



Title	<i>Reference Design Report for a 10 W Dual Output Power Supply Using InnoSwitch3™-EP INN3672C-H602</i>
Specification	90 VAC – 265 VAC Input 5 V, 0.3 A and 12 V, 0.7 A Outputs
Application	Dual Output Open Frame Industrial Power Supply
Author	Applications Engineering Department
Document Number	RDR-611
Date	January 29, 2019
Revision	1.3

Summary and Features

- InnoSwitch3-EP - industry first AC/DC ICs with isolated, safety rated integrated feedback
- Built in synchronous rectification for >85% efficiency at nominal AC input
- All the benefits of secondary side control with the simplicity of primary side regulation
 - Insensitive to transformer variation
 - Extremely fast transient response independent of load timing
- Meets output cross regulation requirements without linear regulators
- Primary sensed output overvoltage protection (OVP) eliminates optocoupler for fault protection
- Accurate thermal protection with hysteretic shutdown
- Input voltage monitor with accurate brown-in / brown-out and overvoltage protection

PATENT INFORMATION

The products and applications illustrated herein (including transformer construction and circuits external to the products) may be covered by one or more U.S. and foreign patents, or potentially by pending U.S. and foreign patent applications assigned to Power Integrations. A complete list of Power Integrations' patents may be found at www.powerint.com. Power Integrations grants its customers a license under certain patent rights as set forth at <http://www.powerint.com/ip.htm>.

Power Integrations

5245 Hellyer Avenue, San Jose, CA 95138 USA.
Tel: +1 408 414 9200 Fax: +1 408 414 9201
www.power.com

Table of Contents

1	Introduction	4
2	Power Supply Specification	6
3	Schematic	7
4	Circuit Description	8
4.1	Input EMI Filtering	8
4.2	InnoSwitch3-EP Primary	8
4.3	InnoSwitch3-EP IC Secondary	8
5	PCB Layout	10
6	Bill of Materials	11
7	Transformer (T1) Specification	12
7.1	Electrical Diagram	12
7.2	Electrical Specifications	12
7.3	Material List	12
7.6	Winding Illustrations	14
8	Transformer Design Spreadsheet	20
9	Performance Data	24
9.1	Full Load Efficiency vs. Line	24
9.2	Efficiency vs. Load (0 A – 0.7 A on 12 V, Full Load on 5 V)	25
9.3	Efficiency vs. Load (0 A – 0.7 A on 12 V, No-Load on 5 V)	26
9.4	No-Load Input Power	27
9.5	5 V Output Power with Low Input Power (No-Load on 12 V)	28
9.6	Line and Load Regulation	29
9.6.1	Line Regulation (Full load)	29
9.6.2	Cross Load Regulation	30
10	Thermal Performance	34
10.1	90 VAC	34
10.2	265 VAC	35
11	Over Temperature Protection (OTP)	36
11.1	90 VAC	36
11.2	265 VAC	37
12	Waveforms	38
12.1	Load Transient Response	38
12.1.1	12 V Load Transient – No-Load at 5 V Output	38
12.1.2	5 V Load Transient – No-Load at 12 V Output	38
12.2	Switching Waveforms	39
12.2.1	InnoSwitch3-EP Waveforms	39
12.2.2	InnoSwitch3-EP Drain Voltage and Current Waveforms During Start-up	39
12.2.3	SR FET Waveforms	40
12.2.4	Output Voltage and Current Waveforms During Start-Up	41
12.2.5	Output Voltage and Current Waveform with Shorted Output (12 V)	42
12.2.6	Overvoltage Protection	43
12.3	Output Ripple Measurements	44

12.3.1	Ripple Measurement Technique	44
12.3.2	Ripple Voltage Waveforms	45
12.4	Brown-in and Brown out	47
13	EMI.....	48
13.1	Conductive EMI	48
13.1.1	Floating Output (QP / AV).....	48
14	Lighting Surge Test.....	52
14.1	Differential Mode Test.....	52
14.2	Common Mode Test.....	52
15	ESD Test	53
16	Revision History	54

Important Note:

Although this board is designed to satisfy safety isolation requirements, the engineering prototype has not been agency approved. Therefore, all testing should be performed using an isolation transformer to provide the AC input to the prototype board.



1 Introduction

This document is an engineering report describing a 0.3 A, 5 V and 0.7 A, 12 V dual output embedded power supply utilizing INN3672C-H602 from the InnoSwitch3-EP family of ICs.

This design shows the high power density and efficiency that is possible due to the high level of integration while still providing exceptional performance.

The document contains the power supply specification, schematic, bill of materials, transformer documentation, printed circuit layout, and performance data.



Figure 1 – Populated Circuit Board Photograph, Top.

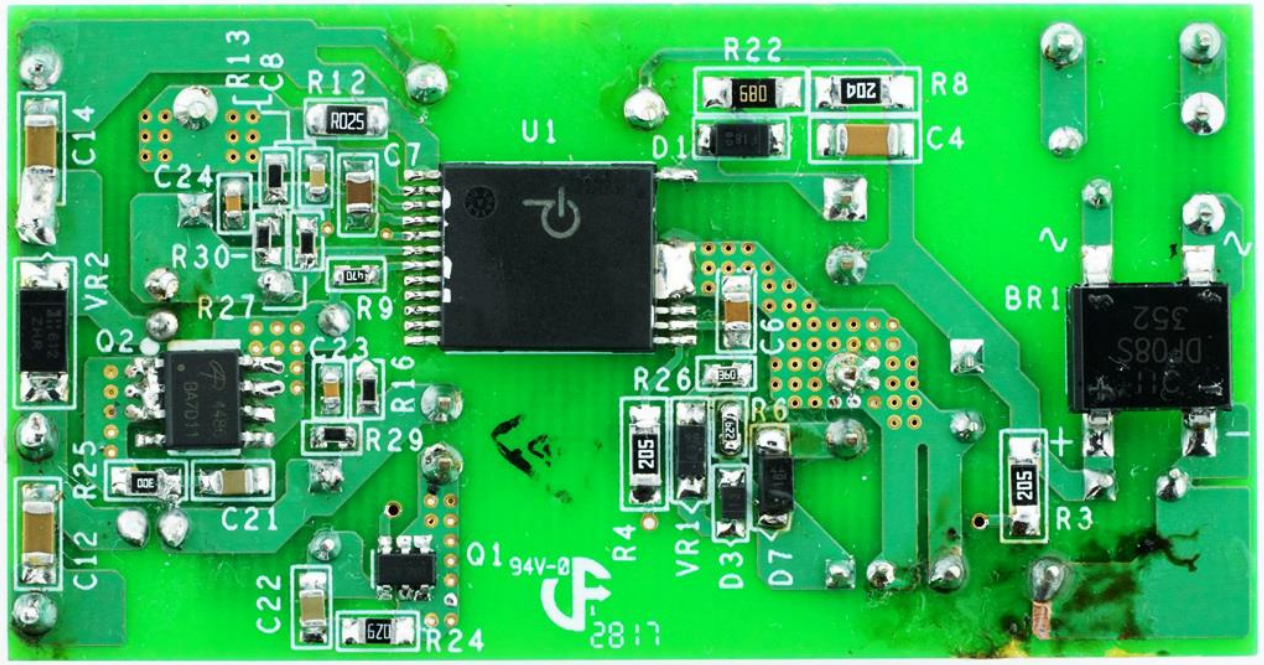

Figure 2 – Populated Circuit Board Photograph, Bottom.

2 Power Supply Specification

The table below represents the minimum acceptable performance of the design. Actual performance is listed in the results section.

Description	Symbol	Min	Typ	Max	Units	Comment
Input						
Voltage	V_{IN}	90		265	VAC	2 Wire Input.
Frequency	f_{LINE}	47	50/60	63	Hz	
Output						
Output Voltage 1	V_{OUT1}	4.75	5	5.25	V	±5 % 20 MHz Bandwidth.
Output Ripple Voltage 1	$V_{RIPPLE1}$			50	mV	
Output Current 1	I_{OUT1}	0		0.3	A	±15 %, (±10 % with 10% Min Load on 12 V.) 20 MHz Bandwidth.
Output Voltage 2	V_{OUT2}	10.2	12	13.8	V	
Output Ripple Voltage 2	$V_{RIPPLE2}$			120	mV	
Output Current 2	I_{OUT2}	0		0.7	A	
Total Output Power						
Continuous Output Power	P_{OUT}			10	W	
Efficiency						
Full Load	η	85			%	Measured at 110 / 230 VAC, P_{OUT} 25 °C. V_{IN} at 230 VAC.
No Load Input Power				30	mW	
Environmental						
Safety						Meets CISPR22B / EN55022B Designed to meet IEC950, UL1950 Class II
Surge Differential		1			kV	1.2/50 μ s surge, IEC 1000-4-5, Series Impedance: Differential Mode: 2 Ω .
Surge Common mode Ring Wave		2			kV	100 kHz Ring Wave, 12 Ω Common Mode.
Ambient Temperature	T_{AMB}	0		40	°C	Free Convection, Sea Level.

3 Schematic

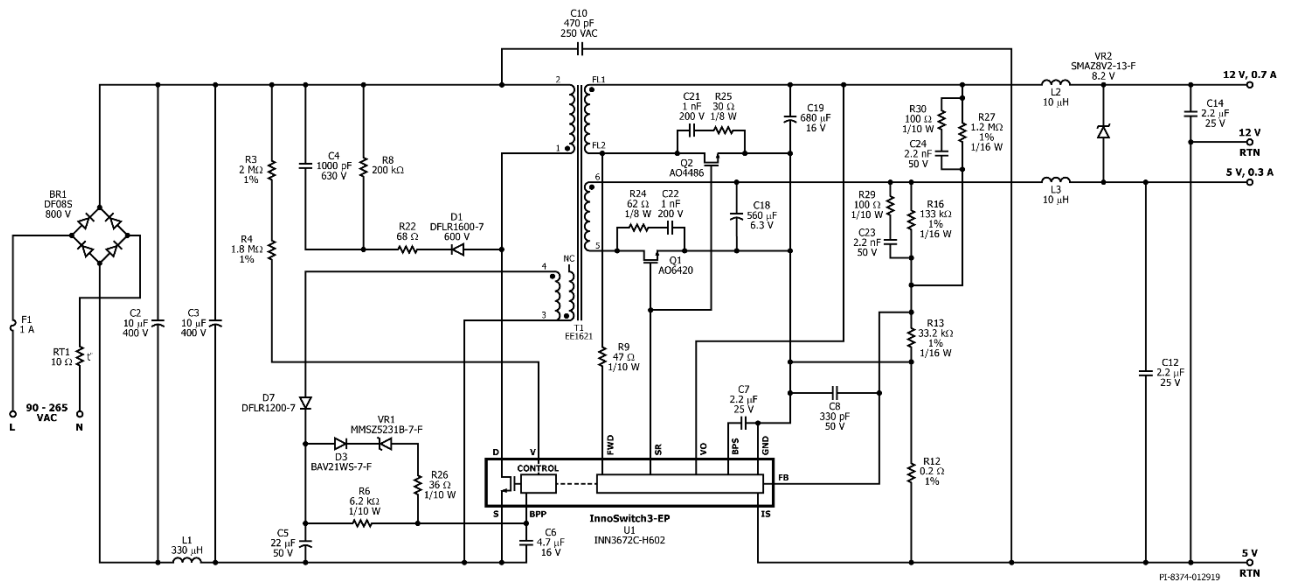

Figure 3 – Schematic.



4 Circuit Description

4.1 *Input EMI Filtering*

Fuse F1 isolates the circuit and provides protection from component failure and thermistor RT1 limits inrush current and for surge protection. Bridge rectifier BR1 rectifies the AC line voltage and provides a full wave rectified DC across the filter consisting of C2 and C3. The differential inductance of L1 with capacitors C2 and C3 provide differential noise filtering.

4.2 *InnoSwitch3-EP Primary*

One side of the transformer primary is connected to the rectified DC bus, the other is connected to the integrated 725 V power MOSFET inside the InnoSwitch3-EP IC (U1).

A low cost RCD clamp formed by D1, R22, R8, and C4 limits the peak drain voltage due to the effects of transformer leakage inductance.

The IC is self-starting, using an internal high-voltage current source to charge the BPP pin capacitor, C6, when AC is first applied. During normal operation the primary side block is powered from an auxiliary winding on the transformer. The output of this is configured as a flyback winding which is rectified and filtered using diode D7 and capacitor C5, and fed in the BPP pin via a current limiting resistor R6. The primary side overvoltage protection is obtained using Zener diode VR1. In the event of overvoltage at output, the increased voltage at the output of the bias winding cause the Zener diode VR1 to conduct and triggers the OVP latch in the primary side controller of the InnoSwitch3-EP IC.

Resistor R3 and R4 provide line voltage sensing and provide a current to U1, which is proportional to the DC voltage across capacitor C3. At approximately 100V DC, the current through these resistors exceeds the line under-voltage threshold, which results in enabling of U1. At approximately 460V DC, the current through these resistors exceeds the line over-voltage threshold, which results in disabling of U1.

4.3 *InnoSwitch3-EP IC Secondary*

The secondary side of the InnoSwitch3-EP provides output voltage, output current sensing and drive to a MOSFET providing synchronous rectification.

Total output current is sensed by R12 between the IS and GND pins with a threshold of approximately 35 mV to reduce losses. Once the current sense threshold is exceeded the device adjusts the number of switch pulses to maintain a fixed total output current.

Output rectification for the 5 V output is provided by SR FET Q1. Very low ESR capacitor C18 provides filtering, and inductor L3 and capacitor C12 form a second stage filter that significantly attenuates the high frequency ripple and noise at the 5 V output.



Output rectification for the 12 V output is provided by SR FET Q2. Very low ESR capacitors C19 provides filtering, and Inductor L2 and capacitor C14 form a second stage filter that significantly attenuates the high frequency ripple and noise at the 12 V output.

RC snubber networks comprising R24 and C22 for Q1, R25 and C21 for Q2 damp high frequency ringing across SR FETs, which results from leakage inductance of the transformer windings and the secondary trace inductances.

The gates of Q1 and Q2 are turned on based on the winding voltage sensed via R9 and the FWD pin of the IC. In continuous conduction mode operation, the power MOSFET is turned off just prior to the secondary side controller commanding a new switching cycle from the primary. In discontinuous mode the MOSFET is turned off when the voltage drop across the MOSFET falls below a threshold ($V_{SR(TH)}$). Secondary side control of the primary side MOSFET ensure that it is never on simultaneously with the synchronous rectification MOSFET. The MOSFET drive signal is output on the SR pin.

The secondary side of the IC is self-powered from either the secondary winding forward voltage or the output voltage. The output voltage powers the device, fed into the VO pin and charges the decoupling capacitor C7 and an internal regulator. The unit enters auto-restart when the sensed output voltage is lower than 3 V.

Resistor R16, R27 and R13 form a voltage divider network that senses the output voltage from both outputs for better cross-regulation. Zener diode VR2 improves the cross regulation when only the 5 V output is loaded, which results in the 12 V output operating at the higher end of the specification. The InnoSwitch3-EP IC has an internal reference of 1.265 V. Feedback compensation networks comprising capacitors C23, C24 and resistors R29, R30 reduce the output ripple voltage. Capacitor C8 provides decoupling from high frequency noise affecting power supply operation.

5 PCB Layout

PCB copper thickness is 2 oz (2.8 mils / 71 μm) unless otherwise stated.

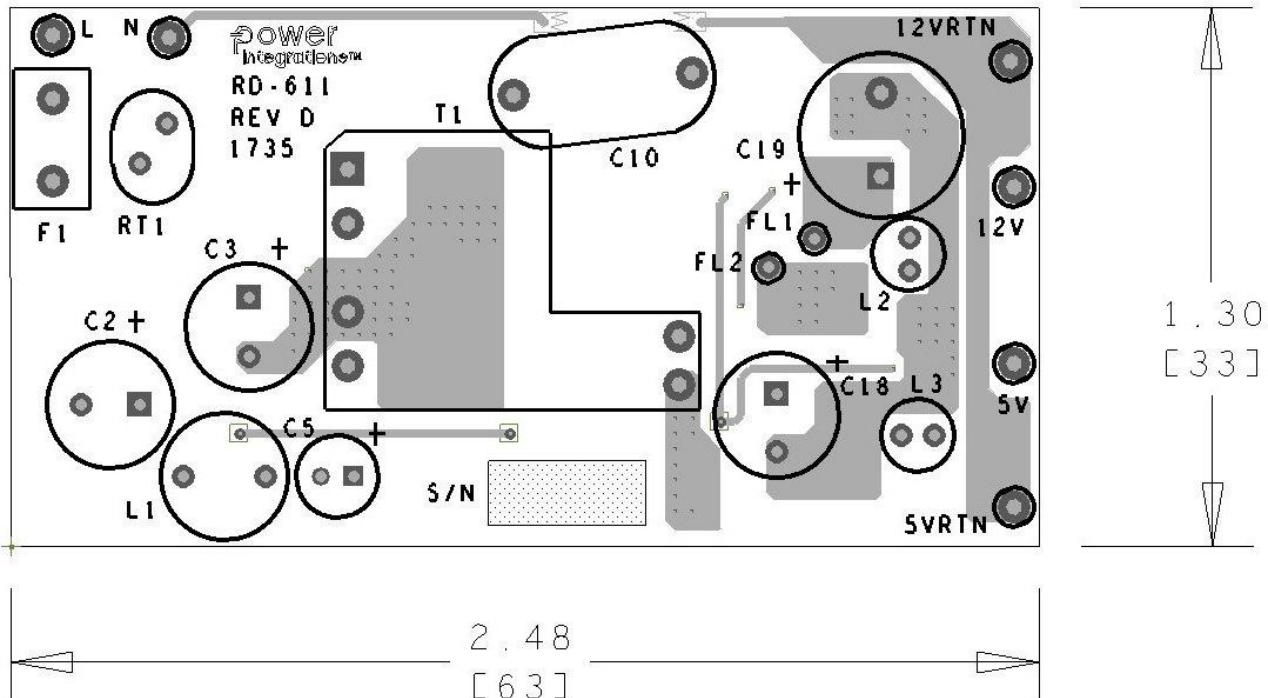

Figure 4 – Printed Circuit Layout, Top.

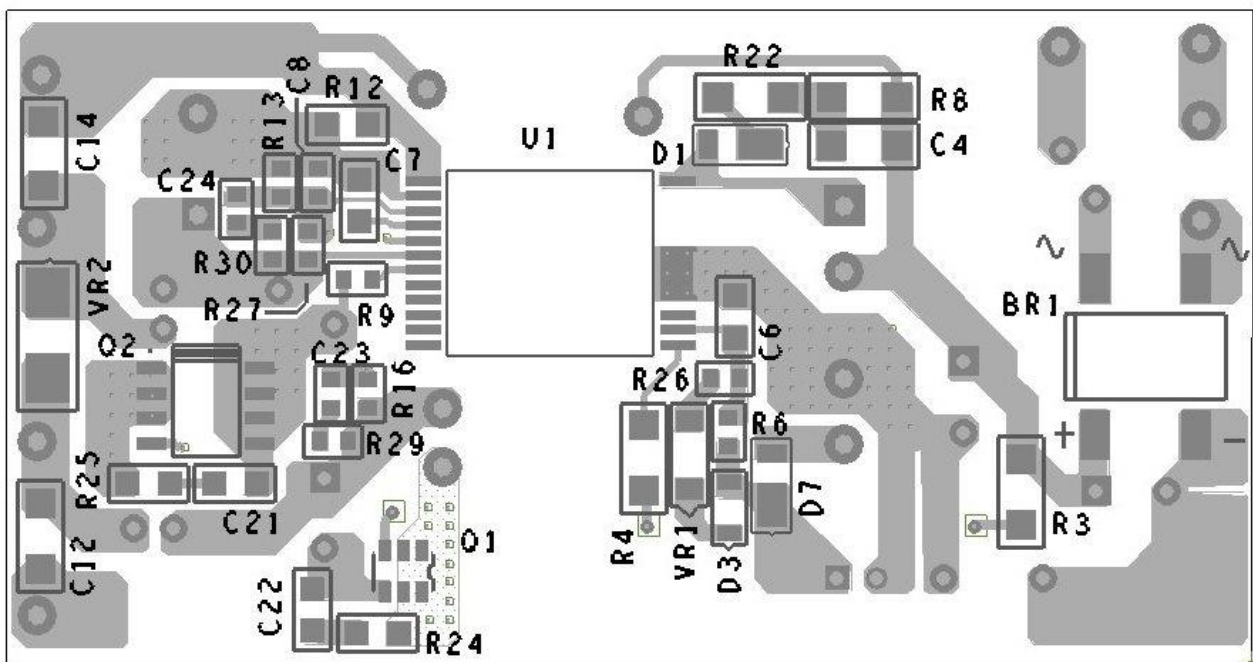

Figure 5 – Printed Circuit Layout, Bottom.

6 Bill of Materials

Item	Qty	Ref Des	Description	Mfg Part Number	Mfg
1	1	BR1	800 V, 1 A, Bridge Rectifier, SMD, DFS	DF08S	Diodes, Inc.
2	2	C2 C3	10 μ F, 400 V, Electrolytic, (8 x 14)	EWB2GM100F140T	Aishi
3	1	C4	1000 pF, 630 V, Ceramic, X7R, 1206	C1206C102KBRCTU	Kemet
4	1	C5	22 μ F, 50 V, Electrolytic, (5 x 11)	UPW1H220MDD	Nichicon
5	1	C6	4.7 μ F, 16 V, Ceramic, X7R, 0805	GRM21BR71C475KA73L	Murata
6	1	C7	2.2 μ F, 25 V, Ceramic, X7R, 0805	C2012X7R1E225M	TDK
7	1	C8	330 pF 50 V, Ceramic, X7R, 0603	CC0603KRX7R9BB331	Yageo
8	1	C10	470 pF, 250 VAC, Film, X1Y1	CD95-B2GA471KYNS	TDK
9	2	C12 C14	2.2 μ F, 25 V, Ceramic, X7R, 1206	TMK316B7225KL-T	Taiyo Yuden
10	1	C18	560 μ F, 6.3 V, Electrolytic, Radial, Low ESR (8 x 13)	6.3ZLG560MEFC8X11.5	Rubycon
11	1	C19	680 μ F, 16 V, Electrolytic, Radial, Low ESR, 26 m Ω , (10 x 16)	EEU-FM1C681	Panasonic
12	2	C21 C22	1 nF, 200 V, Ceramic, X7R, 0805	08052C102KAT2A	AVX
13	2	C23 C24	2.2 nF 50 V, Ceramic, X7R, 0603	C0603C222K5RACTU	Yageo
14	1	D1	600 V, 1 A, Rectifier, Glass Passivated, POWERDI123	DFLR1600-7	Diodes, Inc.
15	1	D3	250 V, 0.2 A, Fast Switching, 50 ns, SOD-323	BAV21WS-7-F	Diodes, Inc.
16	1	D7	200 V, 1 A, Rectifier, Glass Passivated, POWERDI123	DFLR1200-7	Diodes, Inc.
17	1	F1	1 A, 250 V, Slow, Long Time Lag, RST 1	RST 1	Belfuse
18	1	L1	330 μ H, 0.55 A, 9 x 11.5 mm	SBC3-331-551	Tokin
19	2	L2 L3	Inductor, 10 μ H, Unshielded, Wirewound, 950mA, 140 m Ω Max, Radial	11R103C	Murata Power
20	1	Q1	MOSFET, N-CH, 60V, 4.2A, 6T50P	AO6420	Alpha & Omega Semi
21	1	Q2	MOSFET, N-CH, 100 V, 4.2A (Ta), 3.1W (Ta), 79 m Ω @ 3 A, 10 V, 8SOIC	AO4486	Alpha & Omega Semi
22	1	R3	RES, 2.00 M Ω , 1%, 1/4 W, Thick Film, 1206	ERJ-8ENF2004V	Panasonic
23	1	R4	RES, 1.80 M Ω , 1%, 1/4 W, Thick Film, 1206	ERJ-8ENF1804V	Panasonic
24	1	R6	RES, 6.2 k Ω , 5%, 1/10 W, Thick Film, 0603	ERJ-3GEYJ622V	Panasonic
25	1	R8	RES, 200 k Ω , 5%, 1/4 W, Thick Film, 1206	ERJ-8GEYJ204V	Panasonic
26	1	R9	RES, 47 Ω , 5%, 1/10 W, Thick Film, 0603	ERJ-3GEYJ470V	Panasonic
27	1	R12	RES, 0.02 Ω , 1%, 1/4 W, Thick Film, 0805	RL0805FR-7W0R02L	Yageo
28	1	R13	RES, 33.2 k Ω , 1%, 1/16 W, Thick Film, 0603	ERJ-3EKF3322V	Panasonic
29	1	R16	RES, 133 k Ω , 1%, 1/16 W, Thick Film, 0603	ERJ-3EKF1333V	Panasonic
30	1	R22	RES, 68 Ω , 5%, 1/4 W, Thick Film, 1206	ERJ-8GEYJ680V	Panasonic
31	1	R24	RES, 62 Ω , 5%, 1/8 W, Thick Film, 0805	ERJ-6GEYJ620V	Panasonic
32	1	R25	RES, 30 Ω , 5%, 1/8 W, Thick Film, 0805	ERJ-6GEYJ300V	Panasonic
33	1	R26	RES, 36 Ω , 5%, 1/10 W, Thick Film, 0603	ERJ-3GEYJ360V	Panasonic
34	1	R27	RES, 1.20 M Ω , 1%, 1/16 W, Thick Film, 0603	ERJ-3EKF1204V	Panasonic
35	2	R29 R30	RES, 100 Ω , 5%, 1/10 W, Thick Film, 0603	ERJ-3GEYJ101V	Panasonic
36	1	RT1	NTC Thermistor, 10 Ω , 0.7 A	MF72-010D5	Cantherm
37	1	T1	Bobbin, EE1621, Vertical, 8 pins, 4pri, 4sec Transformer	EE-1621 POL-INN031	Shen Zhen Xin Yu Jia Premier Magnetics
38	1	U1	InnoSwitch-3EP, InSOP24D	INN3672C-H602	Power Integrations
39	1	VR1	DIODE ZENER 5.1V 500MW SOD123	MMSZ5231B-7-F	Diodes, Inc.
40	1	VR2	DIODE, ZENER, 8.2 V, \pm 5%, 1 W, DO-214AC, SMA	SMAZ8V2-13-F	Diodes, Inc.
41	1	12V	Test Point, PC MINI, .040"(1.02mm)D, YELLOW, THRU-HOLE MOUNT	5004	Keystone
42	2	12VRTN, L	Test Point, BLK, Miniature THRU-HOLE MOUNT	5001	Keystone
43	1	5V	Test Point, RED, Miniature THRU-HOLE MOUNT	5000	Keystone
44	2	5VRTN, N	Test Point, WHT, Miniature THRU-HOLE MOUNT	5002	Keystone

7 Transformer (T1) Specification

7.1 Electrical Diagram

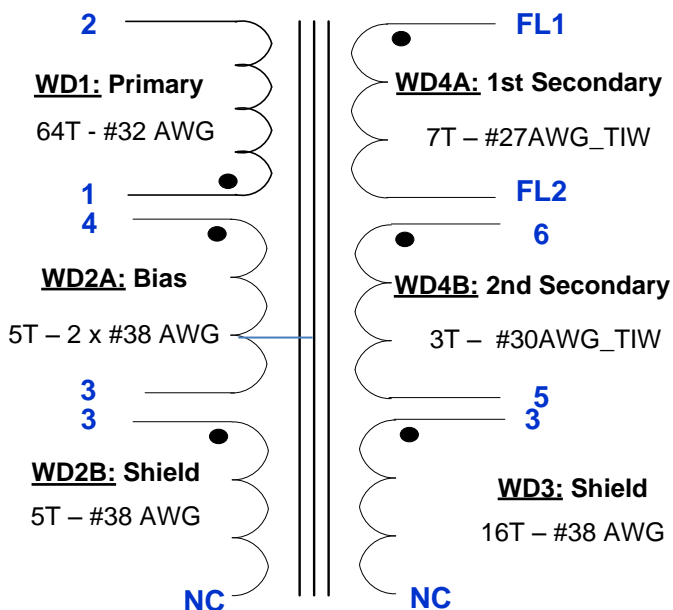

Figure 6 – Transformer Electrical Diagram.

7.2 Electrical Specifications

Parameter	Condition	Spec.
Nominal Primary Inductance	Measured at 1 V _{PK-PK} , 100 kHz switching frequency, between pin 1 and 2, with all other windings open.	1180 μH ±7%
Primary Leakage Inductance	Between pin 1 and 2, with FL1, FL2, 5, 6 shorted.	40 μH (Max).

7.3 Material List

Item	Description
[1]	Core: EE1621; Hong Kong Magnetics, ME 95 or Equivalent; Gapped for ALG of 218nH/T ² .
[2]	Bobbin: EE1621-Vertical – 8 pins (4/4), SHEN ZEN XIN YU JIA Technology LTD.
[3]	Magnet Wire: #32 AWG, Double Coated.
[4]	Magnet Wire: #38 AWG, Double Coated.
[5]	Magnet Wire: #27 AWG, Triple Insulated Wire.
[6]	Magnet Wire: #30 AWG, Triple Insulated Wire.
[7]	Barrier Tape: 3M 1298 Polyester Film, 1 mil Thickness, 5.5 mm Wide.
[8]	Copper Foil: 2 mil Thick, 4.0mm x 20.0 mm.
[9]	Tape: 3M Polyester Film, 1 mil Thick, 7 mm Wide.
[10]	Varnish: Dolph BC-359.

7.4 **Transformer Build Diagram**

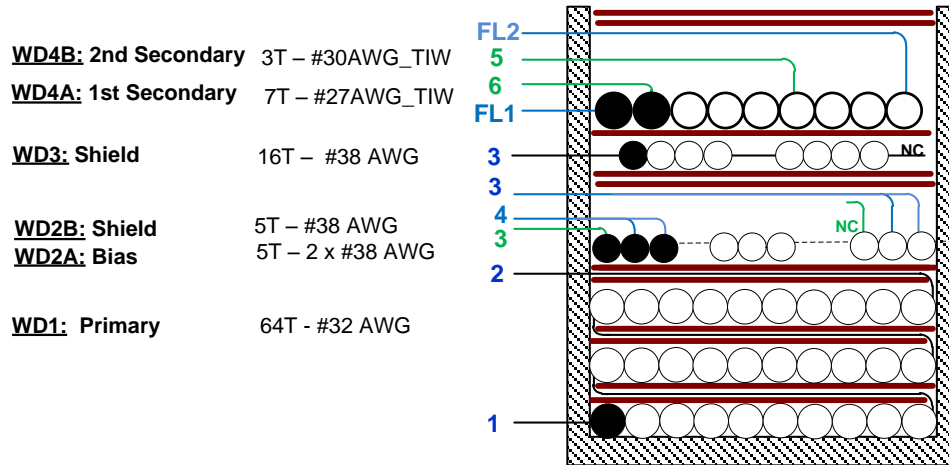

Figure 7 – Transformer Electrical Diagram.

7.5 **Winding Instructions**

WD1 Primary	Start at pin 1, wind 22 turns of wire Item [3] from left to right and bring it back to the left and turn 2 layers of tape Item [7] for insulation. Continue to wind 22 turns on the second layer using the same wire from left to right and bring it back to the left and turn 2 layers of tape Item [7] for insulation. Continue to wind 20 turns on the third layer using the same wire from left to right and bring it back to the left and terminate the wire on pin 2.
Insulation	2 layer of tape Item [7] for insulation.
WD2A Bias & WD2B Shield	Take 3 wires Item [4], start at pin 4 for 2 wires (Bias), start at pin 3 for 1 wire(Shield),wind 5 turns for all 3 wires from left to right, cut 1 wire (Shield)and leave no-connection for WD2B-Shield. Bring other 2 wires (Bias)to the left and terminate to pin 3.
Insulation	2 layer of tape Item [7] for insulation.
WD3 Shield	Take 1 wire Item [4], start at pin 3 wind 16 turns from left to right, leave no-connection for WD3-Shield. Shield should be wind equally spaced and by 4 turns (Please see illustration).
Insulation	1 layer of tape Item [7] for insulation.
WD4A 1st Secondary & WD4B 2nd Secondary	Take 1 wire Item [5], designate start leads FL1 for WD4A. Wind 7 turns for WD4A and designate the finish lead to FL2. Take 1 wire Item [6] and start at pin6, wind first turn for WD4B beginning right after the first turn of WD4A and 2 nd turn right after the 2 nd turn of WD4A and 3 rd turn right after the 3 rd turn of WD4A. Please see illustration. Turn 1 layer of tape and bring two wire to the left and turn another 1 layer of tape for insulation. Terminate finish of WD4B to pin 5. 2 layers of tape Item [7] for secure windings and insulation
Finish	Cut short FL1 to ~22.0 mm and FL2 to ~19.0 mm. Gap the core halves to get 1180 μH. Prepare copper foil Item [8], solder wire Item [3] at the middle to connect to pin 3, and then place on top core halves. Then secure 2 core halves with 2 layers of tape Item [9]. Remove pins: 7 and 8. Varnish with Item [10].

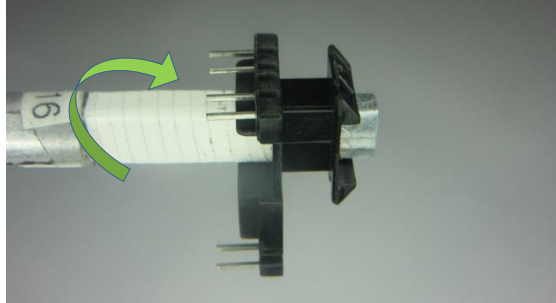
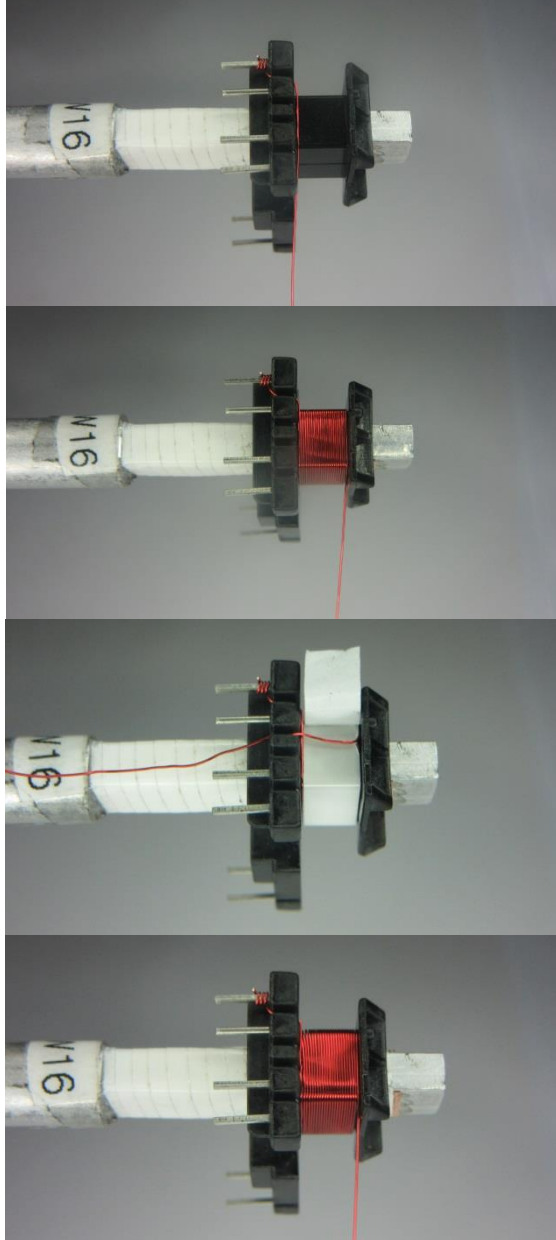

7.6 **Winding Illustrations**

<p>Winding Preparation</p>		<p>For the purpose of these instructions, bobbin Item [1] is oriented on winder such that pin side is on the left side.</p>
<p>WD1 Primary (1st Layer)</p>		<p>Start at pin 1, wind 22 turns of wire Item [3] from left to right and bring it back to the left and turn 2 layers of tape Item [7] for insulation.</p>

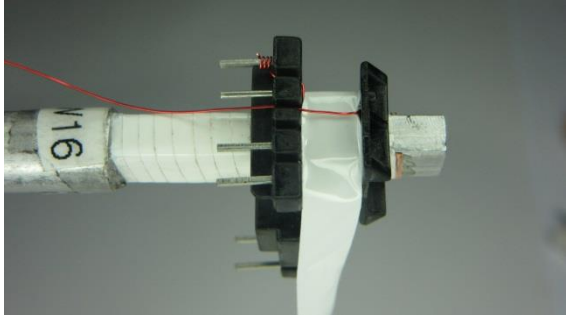
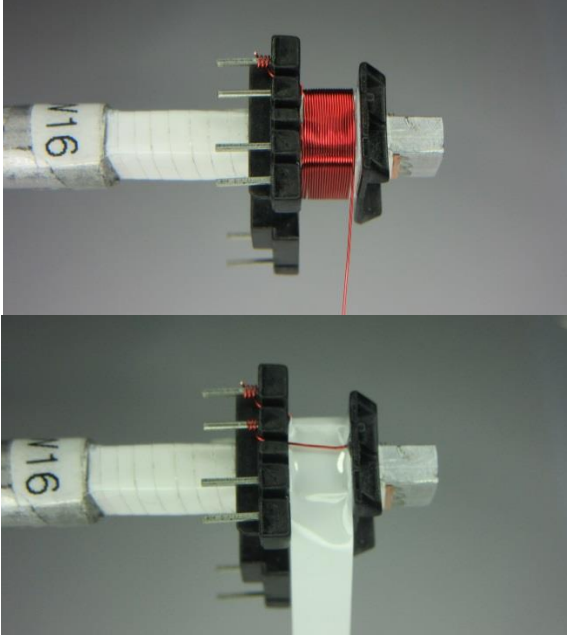
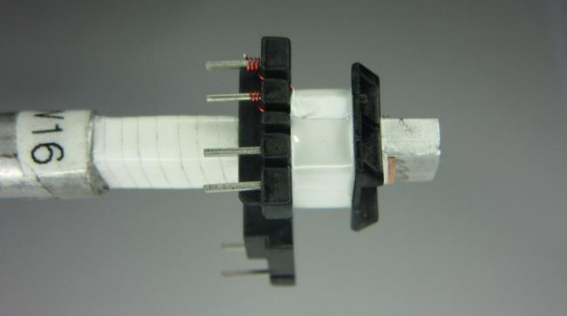
<p>WD1 Primary (2nd Layer)</p>		<p>Continue to wind 22 turns on the second layer using the same wire from left to right and bring it back to the left and turn 2 layers of tape Item [7] for insulation.</p>
<p>WD1 Primary (3rd Layer)</p>		<p>Continue to wind 20 turns on the third layer using the same wire from left to right and bring it back to the left and terminate the wire on pin 2.</p>
		<p>2 layer of tape Item [7] for insulation.</p>

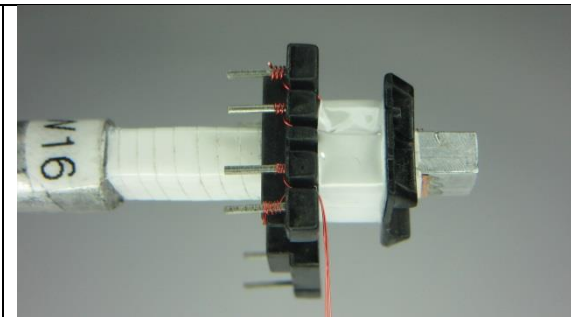
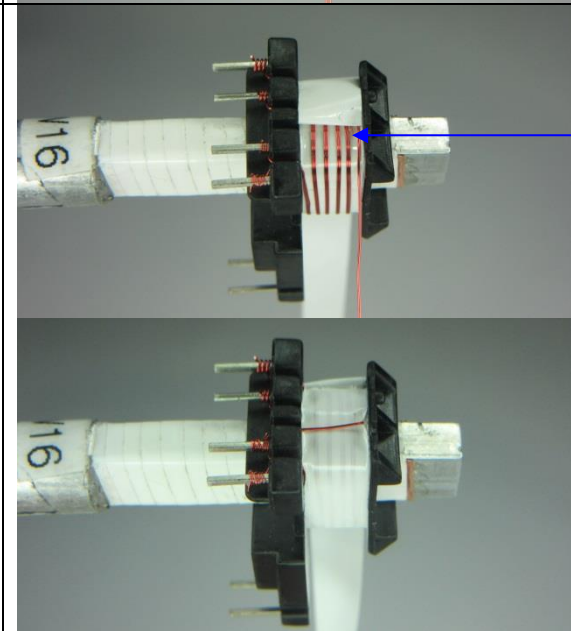
		<p>Start at pin 3 (for 1 wire shield),wind 5 turns for all 3 wires from left to right.</p>
<p>WD2A Bias & WD2B Shield</p>		<p>Cut wire and leave no connection for WD2B shield</p> <p>Bring other 2 wire (Bias) to the left and terminate to pin3. 2 layer of tape Item [7] for insulation.</p>

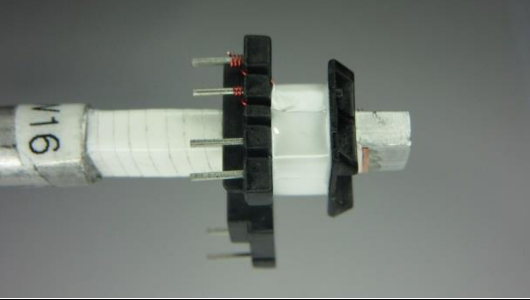
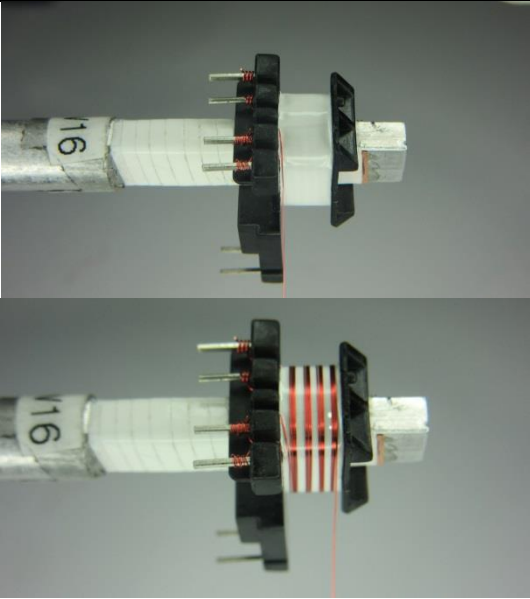
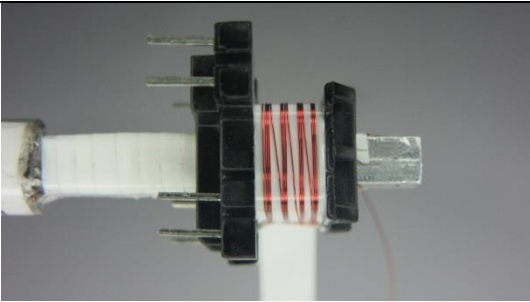
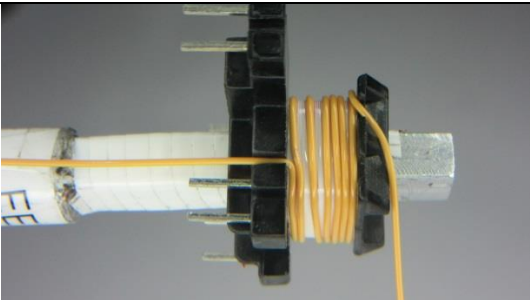
<p>Insulation</p>		<p>2 layer of tape Item [8] for insulation.</p>
<p>WD3 Shield</p>		<p>Take 1 wire Item [4], start at pin 3 wind 16 turns from left to right.</p> <p>Shield should be wind equally spaced and by 4 turns.</p>
<p>Insulation</p>		<p>Back view (secondary side). 1 layer of tape Item [7] for insulation.</p>
<p>WD4A 1st Secondary and WD4B 2nd Secondary</p>		<p>Take 1 wire Item [5], designate start leads FL1 for WD4A. Wind 7 turns for WD4A and designate the finish lead to FL2.</p>

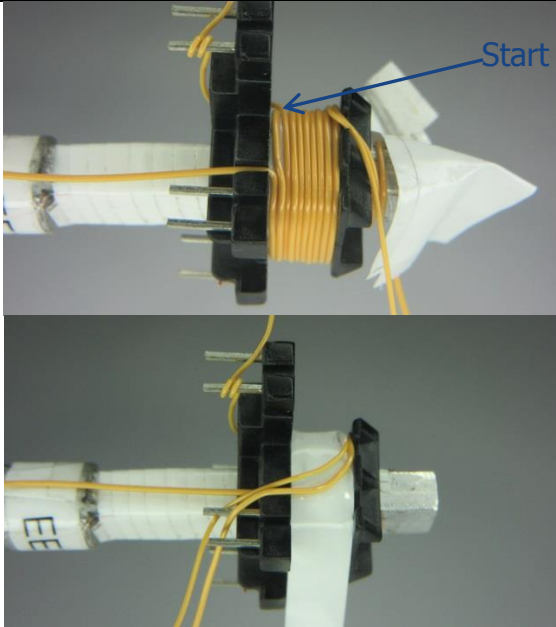
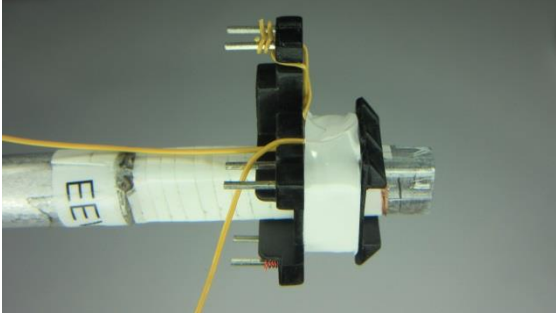
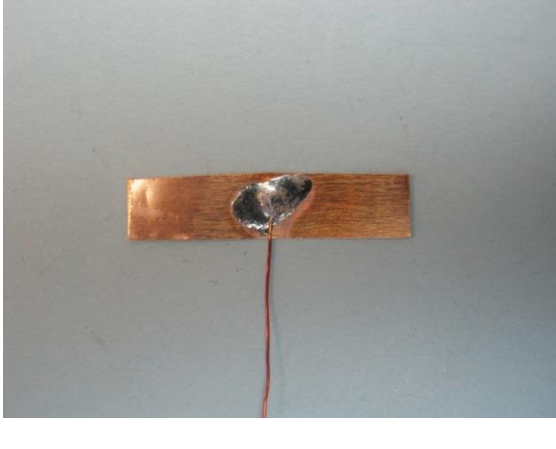
		<p>Take 1 wire Item [6] and start at pin 6, wind first turn for WD4B beginning right after the first turn of WD4A and 2nd turn right after the 2nd turn of WD4A and 3rd turn right after the 3rd turn of WD4A.</p> <p>1 layer of tape Item [8] for insulation.</p>
<p>Insulation</p>		<p>Bring two wires to the left and turn another 1 layer of tape for insulation. Terminate finish of WD4B to pin 5.</p>
<p>Finish</p>		<p>Cut short FL1 to ~22.0 mm, and FL2 to ~19.0 mm. Gap the core halves to get 1180 μH. Prepare copper foil Item [8], solder wire Item [3] at the middle to connect to pin 3, and then place on top core halves. Then secure 2 core halves with 2 layers of tape Item [9]. Remove pins: 7 and 8. Varnish with Item [10].</p>

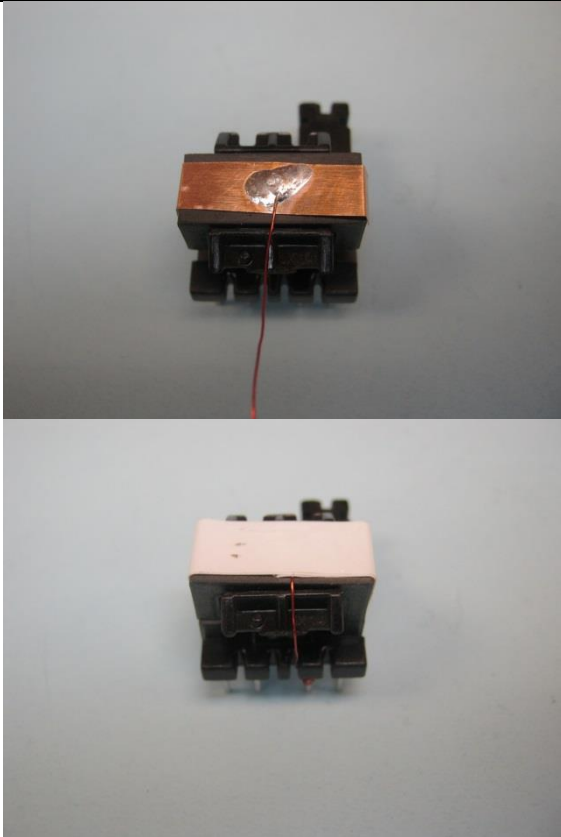
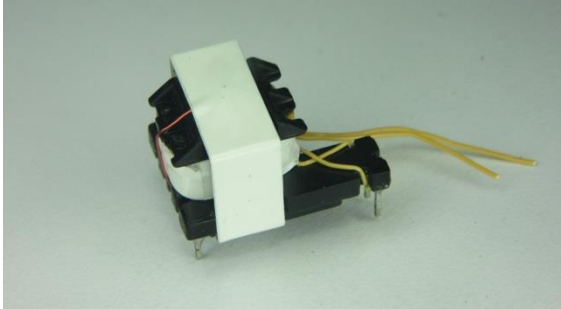
		
Insulation		<p>Wrap 2 layers of tape Item [9] around the transformer for insulation. Remove pins: 7 and 8. Varnish with Item [10].</p>

8 Transformer Design Spreadsheet

ACDC_InnoSwitch3-EP_Flyback_083017; Rev.1.0; Copyright Power Integrations 2017	INPUT	INFO	OUTPUT	UNITS	InnoSwitch3 EP Flyback Design Spreadsheet
APPLICATION VARIABLES					
VIN_MIN	90		90	V	Minimum AC input voltage
VIN_MAX			265	V	Maximum AC input voltage
VIN_RANGE			UNIVERSAL		Range of AC input voltage
LINEFREQ			60	Hz	AC Input voltage frequency
CAP_INPUT	20.0		20.0	uF	Input capacitor
VOUT	12.00		12.00	V	Output voltage at the board
PERCENT_CDC			0%		Cable drop compensation required
IOUT	0.83		0.83	A	Output current
POUT			9.96	W	Output power
EFFICIENCY	0.85		0.85		AC-DC efficiency estimate at full load given that the converter is switching at the valley of the rectified minimum input AC voltage
FACTOR_Z			0.50		Z-factor estimate
ENCLOSURE	OPEN FRAME		OPEN FRAME		Power supply enclosure
PRIMARY CONTROLLER SELECTION					
ILIMIT_MODE	INCREASED		INCREASED		Device current limit mode
DEVICE_GENERIC	INN36X2		INN36X2		Generic device code
DEVICE_CODE			INN3672C		Actual device code
POUT_MAX			10	W	Power capability of the device based on thermal performance
RDSON_100DEG			10.41	Ω	Primary MOSFET on time drain resistance at 100 degC
ILIMIT_MIN			0.50	A	Minimum current limit of the primary MOSFET
ILIMIT_TYP			0.55	A	Typical current limit of the primary MOSFET
ILIMIT_MAX			0.60	A	Maximum current limit of the primary MOSFET
VBREAKDOWN_MOSFET			725	V	Device breakdown voltage
VDRAIN_ON_MOSFET			1.22	V	Primary MOSFET on time drain voltage
VDRAIN_OFF_MOSFET			553.4	V	Peak drain voltage on the primary MOSFET during turn-off
WORST CASE ELECTRICAL PARAMETERS					
FSWITCHING_MAX	82000		82000	Hz	Maximum switching frequency at full load and valley of the rectified minimum AC input voltage
VOR	110.0		110.0	V	Secondary voltage reflected to the primary when the primary MOSFET turns off
VMIN			93.59	V	Valley of the rectified minimum AC input voltage at full power
KP			1.26		Measure of continuous/discontinuous mode of operation
MODE_OPERATION			DCM		Mode of operation
DUTYCYCLE			0.486		Primary MOSFET duty cycle
TIME_ON			7.61	us	Primary MOSFET on-time
TIME_OFF			6.35	us	Primary MOSFET off-time
LPRIMARY_MIN			1102.6	uH	Minimum primary inductance
LPRIMARY_TYP			1185.5	uH	Typical primary inductance
LPRIMARY_TOL	7.0		7.0	%	Primary inductance tolerance
LPRIMARY_MAX			1268.5	uH	Maximum primary inductance
PRIMARY CURRENT					
IPEAK_PRIMARY			0.56	A	Primary MOSFET peak current
IPEDESTAL_PRIMARY			0.00	A	Primary MOSFET current pedestal



Iavg_PRIMARY			0.12	A	Primary MOSFET average current
IRIPPLE_PRIMARY			0.56	A	Primary MOSFET ripple current
IRMS_PRIMARY			0.21	A	Primary MOSFET RMS current
SECONDARY CURRENT					
IPEAK_SECONDARY			5.16	A	Secondary winding peak current
IPEDESTAL_SECONDARY			0.00	A	Secondary winding current pedestal
IRMS_SECONDARY			1.90	A	Secondary winding RMS current
TRANSFORMER CONSTRUCTION PARAMETERS					
CORE SELECTION					
CORE	Custom	Info	Custom		The transformer windings may not fit: pick a bigger core or bobbin and refer to the Transformer Parameters tab for fit calculations
CORE CODE	EE1621		EE1621		Core code
AE	32.50		32.50	mm ²	Core cross sectional area
LE	39.30		39.30	mm	Core magnetic path length
AL	2800		2800	nH/turns ²	Ungapped core effective inductance
VE	980.0		980.0	mm ³	Core volume
BOBBIN	EE1621		EE1621		Bobbin
AW	12.33		12.33	mm ²	Window area of the bobbin
BW	5.40		5.40	mm	Bobbin width
MARGIN	0.0		0.0	mm	Safety margin width (Half the primary to secondary creepage distance)
PRIMARY WINDING					
NPRIMARY			64		Primary turns
BPEAK			3745	Gauss	Peak flux density
BMAX			3381	Gauss	Maximum flux density
BAC			1690	Gauss	AC flux density
ALG			289	nH/turns ²	Typical gapped core effective inductance
LG			0.127	mm	Core gap length
LAYERS_PRIMARY			3		Number of primary layers
AWG_PRIMARY			32	AWG	Primary winding wire AWG
OD_PRIMARY_INSULATED			0.244	mm	Primary winding wire outer diameter with insulation
OD_PRIMARY_BARE			0.202	mm	Primary winding wire outer diameter without insulation
CMA_PRIMARY			301	Cmil/A	Primary winding wire CMA
SECONDARY WINDING					
NSECONDARY			7		Secondary turns
AWG_SECONDARY			24	AWG	Secondary winding wire AWG
OD_SECONDARY_INSULATED			0.815	mm	Secondary winding wire outer diameter with insulation
OD_SECONDARY_BARE			0.511	mm	Secondary winding wire outer diameter without insulation
CMA_SECONDARY			229	Cmil/A	Secondary winding wire CMA
BIAS WINDING					
NBIAS			8		Bias turns
PRIMARY COMPONENTS SELECTION					
Line undervoltage					
BROWN-IN REQUIRED			76.5	V	Required AC RMS line voltage brown-in threshold
RLS			4.52	MΩ	Connect two 2.26 MΩ resistors to the V-pin for the required UV/OV threshold
BROWN-IN ACTUAL			77.0	V	Actual AC RMS brown-in threshold
BROWN-OUT ACTUAL			70.6	V	Actual AC RMS brown-out threshold
Line overvoltage					
OVERVOLTAGE_LINE			339.2	V	Actual AC RMS line over-voltage threshold
Bias diode					
VBIAS			12.0	V	Rectified bias voltage
VF_BIAS			0.70	V	Bias winding diode forward drop
VREVERSE_BIASDIODE			58.67	V	Bias diode reverse voltage (not accounting

					parasitic voltage ring)
CBIAS			22	uF	Bias winding rectification capacitor
CBPP			4.70	uF	BPP pin capacitor
SECONDARY COMPONENTS					
RFB_UPPER			100.00	kΩ	Upper feedback resistor (connected to the first output voltage)
RFB_LOWER			11.80	kΩ	Lower feedback resistor
CFB_LOWER			330	pF	Lower feedback resistor decoupling capacitor
MULTIPLE OUTPUT PARAMETERS					
OUTPUT 1					
VOUT1			12.00	V	Output 1 voltage
IOUT1	0.70		0.70	A	Output 1 current
POUT1			8.40	W	Output 1 power
IRMS_SECONDARY1			1.48	A	Root mean squared value of the secondary current for output 1
IRIPPLE_CAP_OUTPUT1			1.31	A	Current ripple on the secondary waveform for output 1
AWG_SECONDARY1			25	AWG	Wire size for output 1
OD_SECONDARY1_INSULATED			0.760	mm	Secondary winding wire outer diameter with insulation for output 1
OD_SECONDARY1_BARE			0.455	mm	Secondary winding wire outer diameter without insulation for output 1
CM_SECONDARY1			297	Cmils	Bare conductor effective area in circular mils for output 1
NSECONDARY1			7		Number of turns for output 1
VREVERSE_RECTIFIER1			52.84	V	SRFET reverse voltage (not accounting parasitic voltage ring) for output 1
SRFET1	Auto		AOD2816		SRFET selection for output 1
VF_SRFET1			0.020	V	SRFET on-time drain voltage for output 1
VBREAKDOWN_SRFET1			80	V	SRFET breakdown voltage for output 1
RDSON_SRFET1			29.0	mΩ	SRFET on-time drain resistance at 25degC and VGS=4.4V for output 1
OUTPUT 2					
VOUT2	5.00		5.00	V	Output 2 voltage
IOUT2	0.30		0.30	A	Output 2 current
POUT2			1.50	W	Output 2 power
IRMS_SECONDARY2			0.64	A	Root mean squared value of the secondary current for output 2
IRIPPLE_CAP_OUTPUT2			0.56	A	Current ripple on the secondary waveform for output 2
AWG_SECONDARY2			28	AWG	Wire size for output 2
OD_SECONDARY2_INSULATED			0.625	mm	Secondary winding wire outer diameter with insulation for output 2
OD_SECONDARY2_BARE			0.321	mm	Secondary winding wire outer diameter without insulation for output 2
CM_SECONDARY2			127	Cmils	Bare conductor effective area in circular mils for output 2
NSECONDARY2			3		Number of turns for output 2
VREVERSE_RECTIFIER2			22.50	V	SRFET reverse voltage (not accounting parasitic voltage ring) for output 2
SRFET2	Auto		AON7534		SRFET selection for output 2
VF_SRFET2			0.003	V	SRFET on-time drain voltage for output 2
VBREAKDOWN_SRFET2			30	V	SRFET breakdown voltage for output 2
RDSON_SRFET2			8.5	mΩ	SRFET on-time drain resistance at 25degC and VGS=4.4V for output 2
OUTPUT 3					
VOUT3			0.00	V	Output 3 voltage
IOUT3			0.00	A	Output 3 current
POUT3			0.00	W	Output 3 power
IRMS_SECONDARY3			0.00	A	Root mean squared value of the secondary



					current for output 3
IRIPPLE_CAP_OUTPUT3			0.00	A	Current ripple on the secondary waveform for output 3
AWG_SECONDARY3			0	AWG	Wire size for output 3
OD_SECONDARY3_INSULATED			0.000	mm	Secondary winding wire outer diameter with insulation for output 3
OD_SECONDARY3_BARE			0.000	mm	Secondary winding wire outer diameter without insulation for output 3
CM_SECONDARY3			0	Cmils	Bare conductor effective area in circular mils for output 3
NSECONDARY3			0		Number of turns for output 3
VREVERSE_RECTIFIER3			0.00	V	SRFET reverse voltage (not accounting parasitic voltage ring) for output 3
SRFET3	Auto		NA		SRFET selection for output 3
VF_SRFET3			NA	V	SRFET on-time drain voltage for output 3
VBREAKDOWN_SRFET3			NA	V	SRFET breakdown voltage for output 3
RDSON_SRFET3			NA	mΩ	SRFET on-time drain resistance at 25degC and VGS=4.4V for output 3
PO_TOTAL			9.90	W	Total power of all outputs
NEGATIVE OUTPUT	N/A		N/A		If negative output exists, enter the output number; e.g. If VO2 is negative output, select 2
TOLERANCE ANALYSIS					
CORNER_VAC			90	V	Input AC RMS voltage corner to be evaluated
CORNER_ILIMIT	TYP		0.55	A	Current limit corner to be evaluated
CORNER_LPRIMARY	TYP		1185.5	uH	Primary inductance corner to be evaluated
MODE_OPERATION			DCM		Mode of operation
KP			1.467		Measure of continuous/discontinuous mode of operation
FSWITCHING			66635	Hz	Switching frequency at full load and valley of the rectified minimum AC input voltage
DUTYCYCLE			0.448		Steady state duty cycle
TIME_ON			6.72	us	Primary MOSFET on-time
TIME_OFF			8.28	us	Primary MOSFET off-time
IPEAK_PRIMARY			0.52	A	Primary MOSFET peak current
IPEDESTAL_PRIMARY			0.00	A	Primary MOSFET current pedestal
IAVERAGE_PRIMARY			0.12	A	Primary MOSFET average current
IRIPPLE_PRIMARY			0.52	A	Primary MOSFET ripple current
IRMS_PRIMARY			0.20	A	Primary MOSFET RMS current
CMA_PRIMARY			312	Cmil/A	Primary winding wire CMA
BPEAK			3209	Gauss	Peak fux density
BMAX			2986	Gauss	Maximum flux density

9 Performance Data

9.1 Full Load Efficiency vs. Line

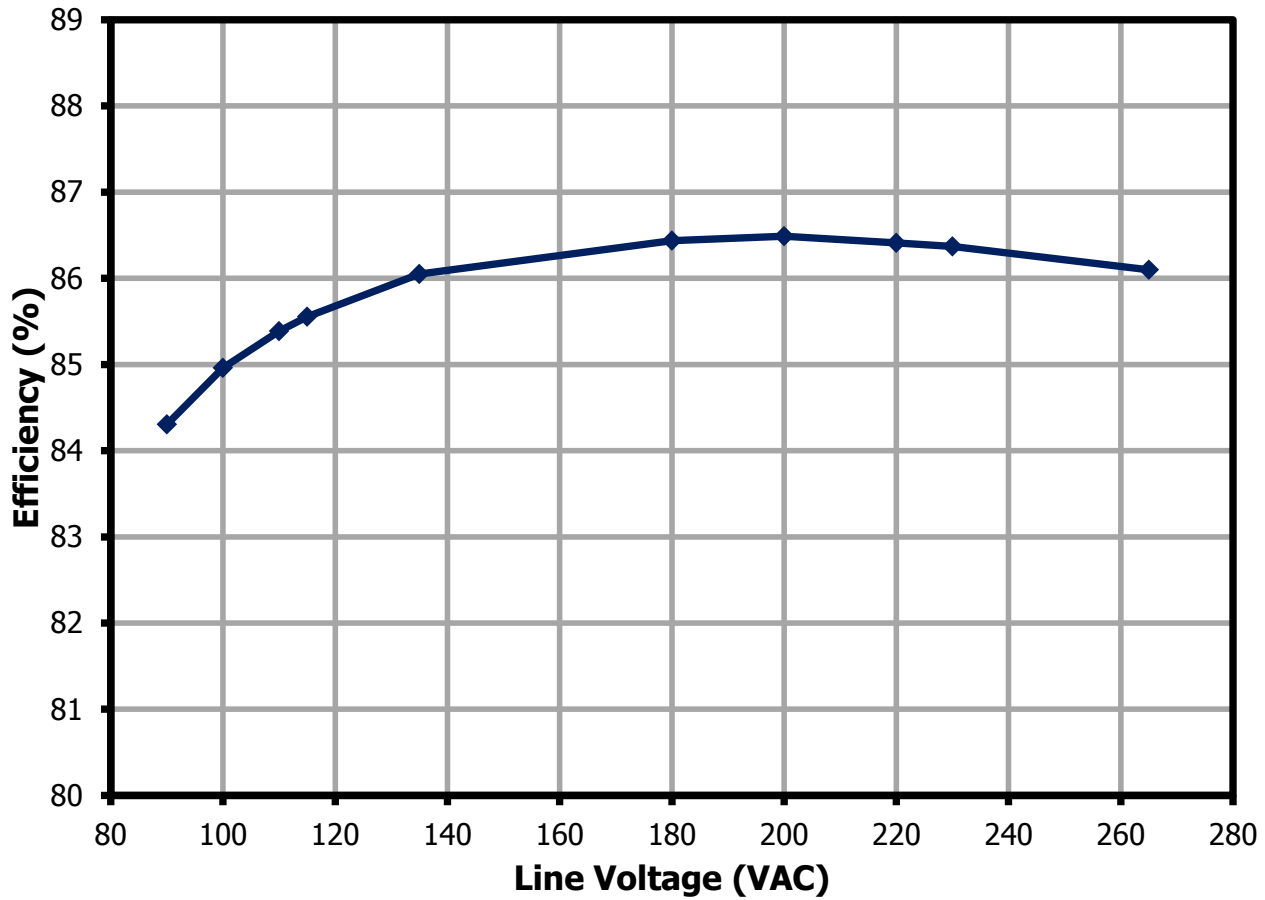

Figure 8 – Full load Efficiency vs. Line Voltage, Room Temperature.

9.2 **Efficiency vs. Load (0 A – 0.7 A on 12 V, Full Load on 5 V)**

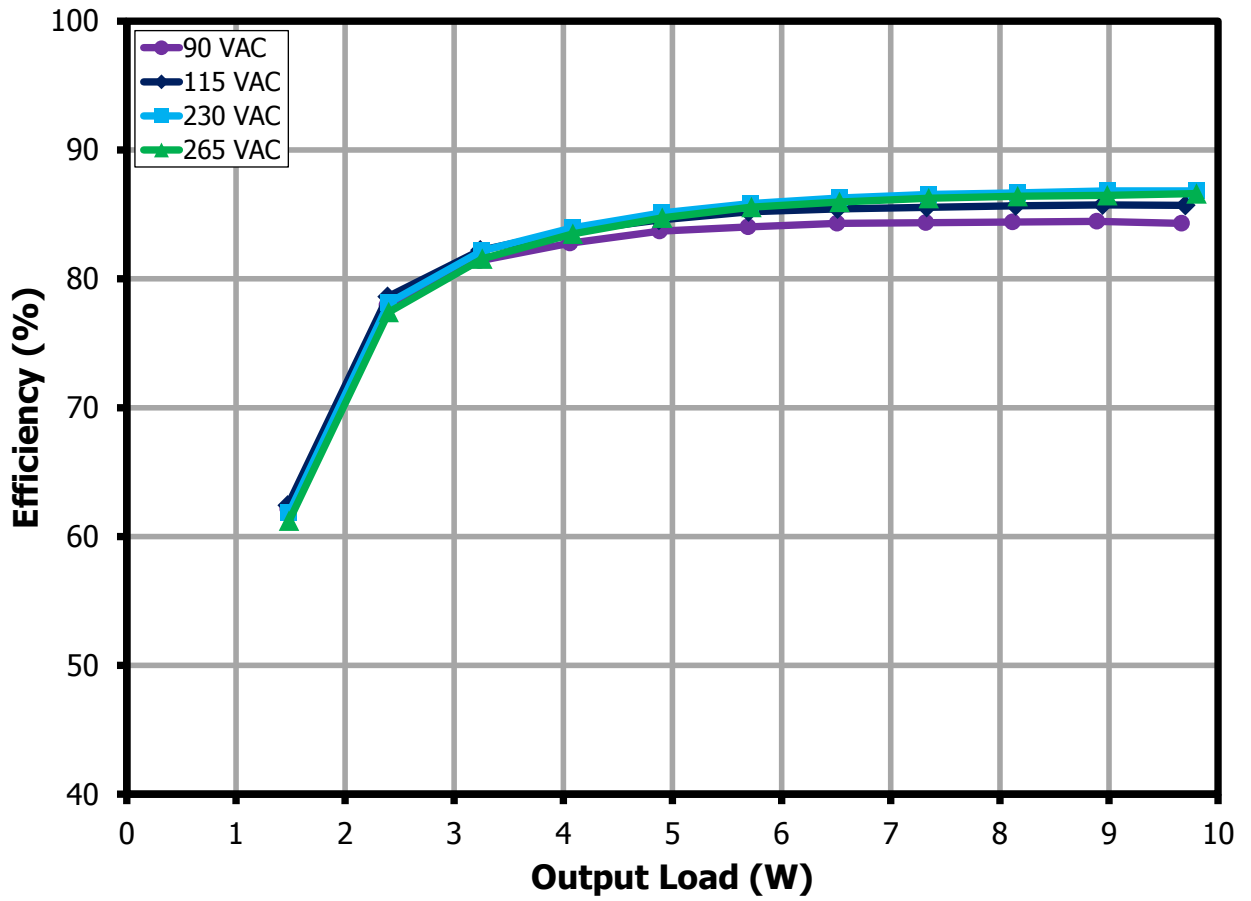

Figure 9 – Efficiency vs. Load, Room Ambient.



9.3 **Efficiency vs. Load (0 A – 0.7 A on 12 V, No-Load on 5 V)**

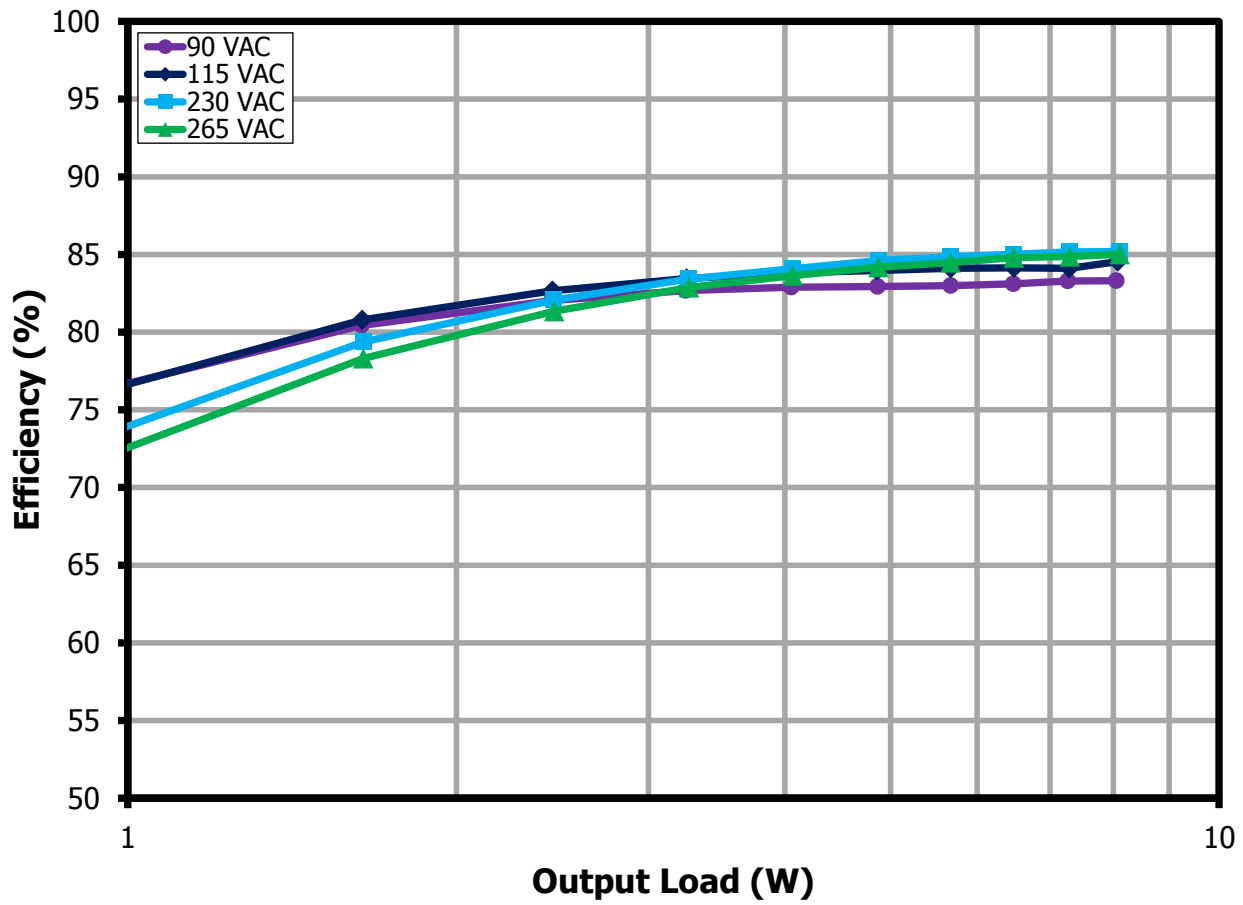

Figure 10 – Efficiency vs. Load (Log Scale to Demonstrate Light Load Performance).

9.4 **No-Load Input Power**

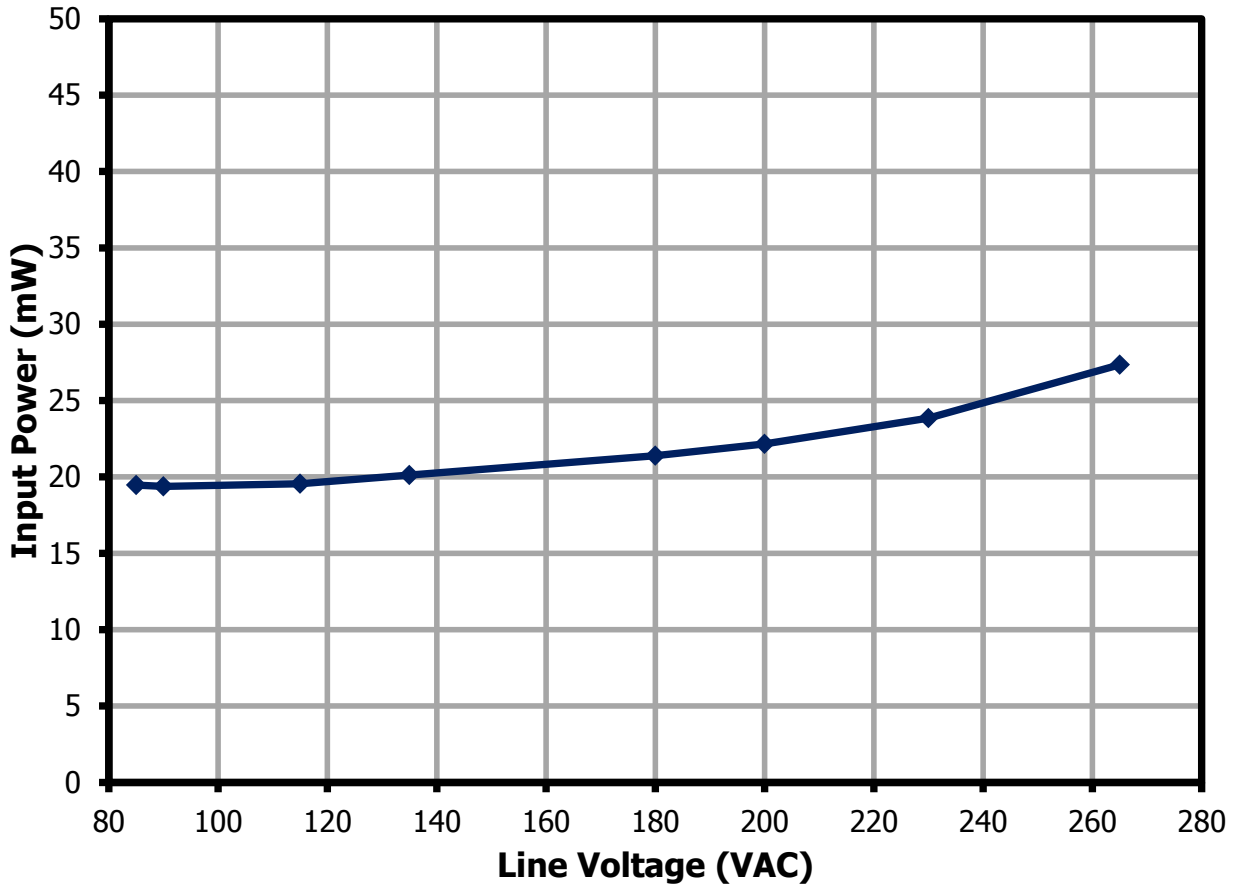

Figure 11 – No-Load Input Power vs. Input Line Voltage, Room Temperature.



9.5 **5 V Output Power with Low Input Power (No-Load on 12 V)**

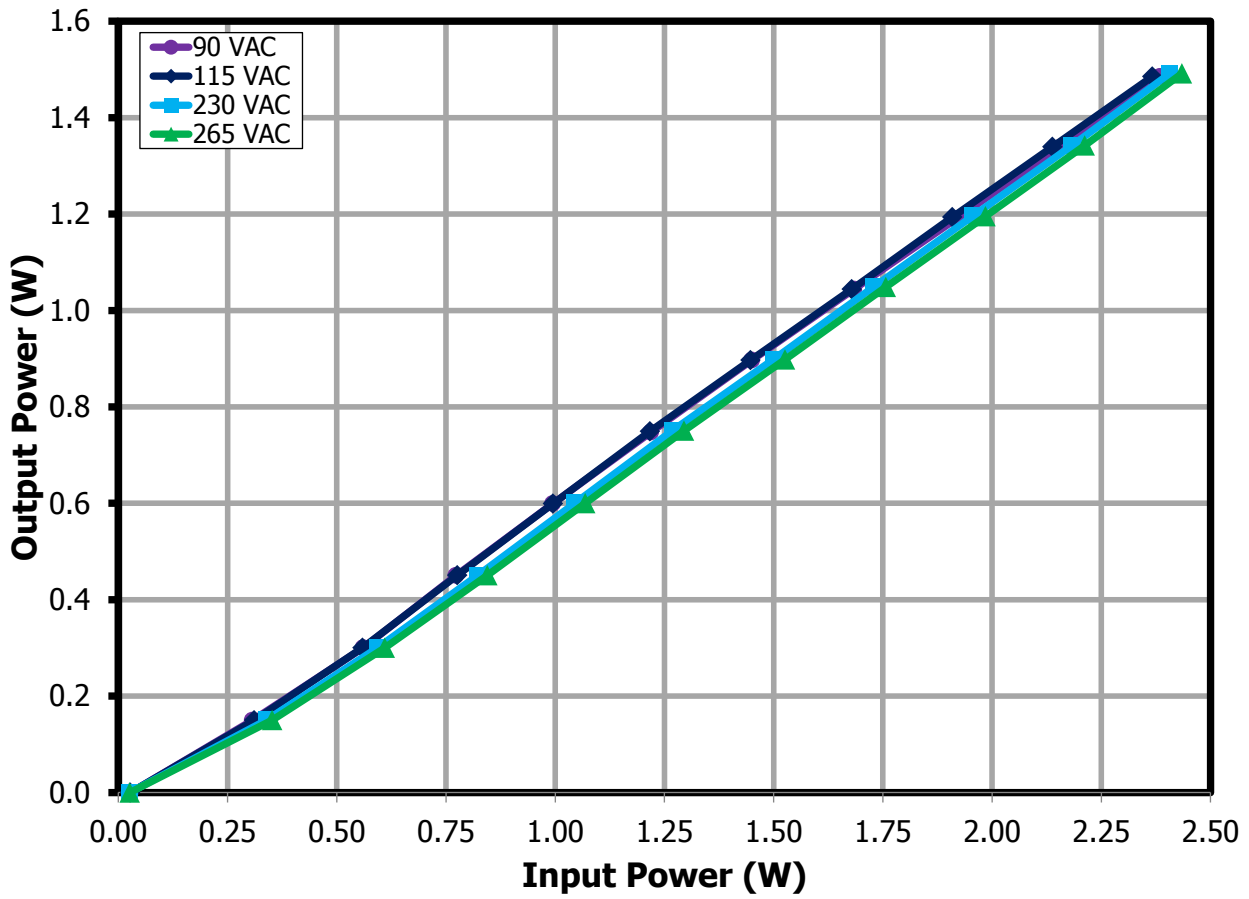

Figure 12 – 5 V Output Power vs. Input Power (12 V No-Load).

9.6 **Line and Load Regulation**

9.6.1 Line Regulation (Full load)

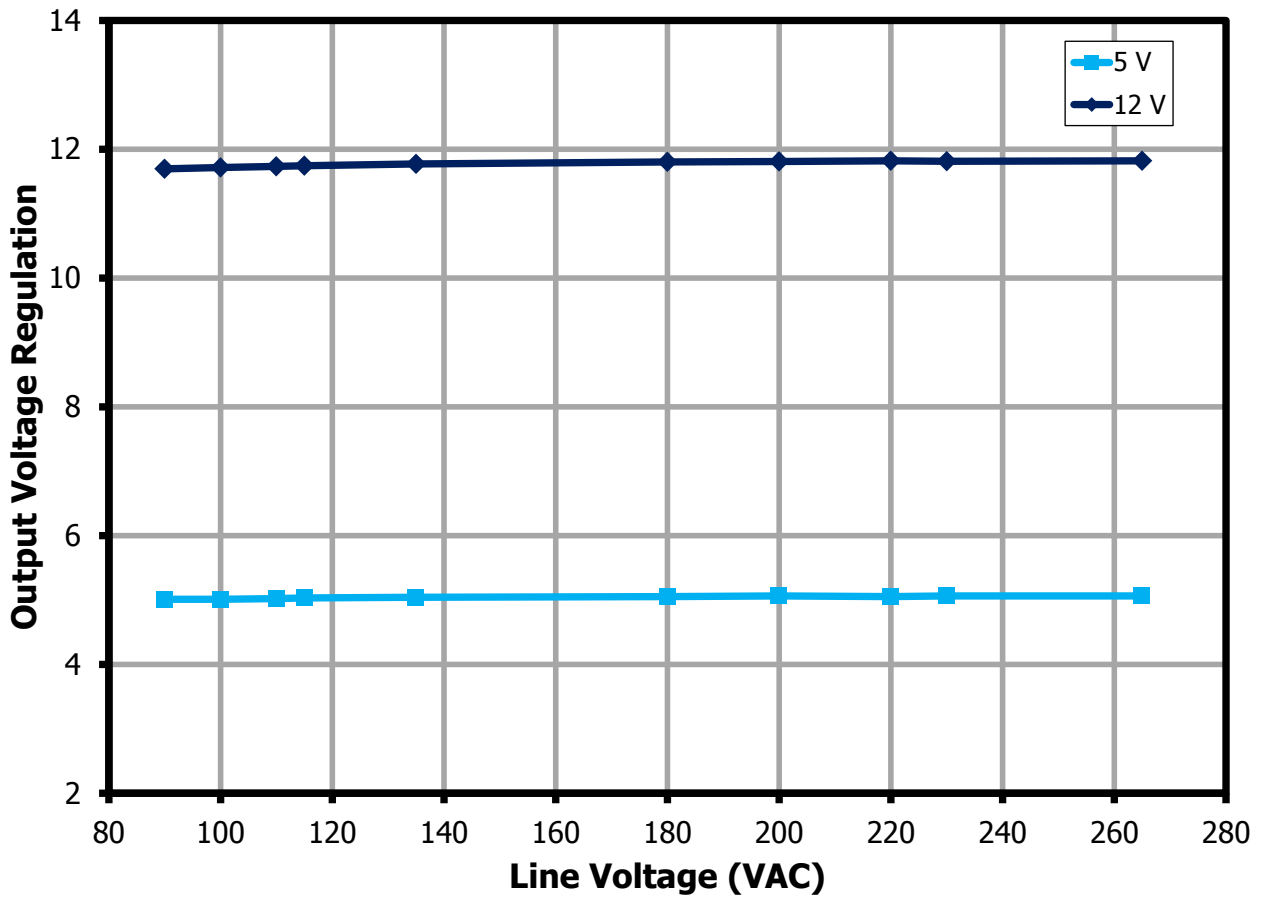

Figure 13 – Output Voltage vs. Input Line Voltage, Room Temperature.

	5 V	12 V
Min.	5.01 V	11.69 V
Max.	5.06 V	11.81 V



9.6.2 Cross Load Regulation

9.6.2.1 12 V Load Change with Full Load on 5 V

Zener diode (8.2 V) across 12 V output to 5 V output (minimum load = 0 A) vs. removing the shunt with 10% minimum to either load.

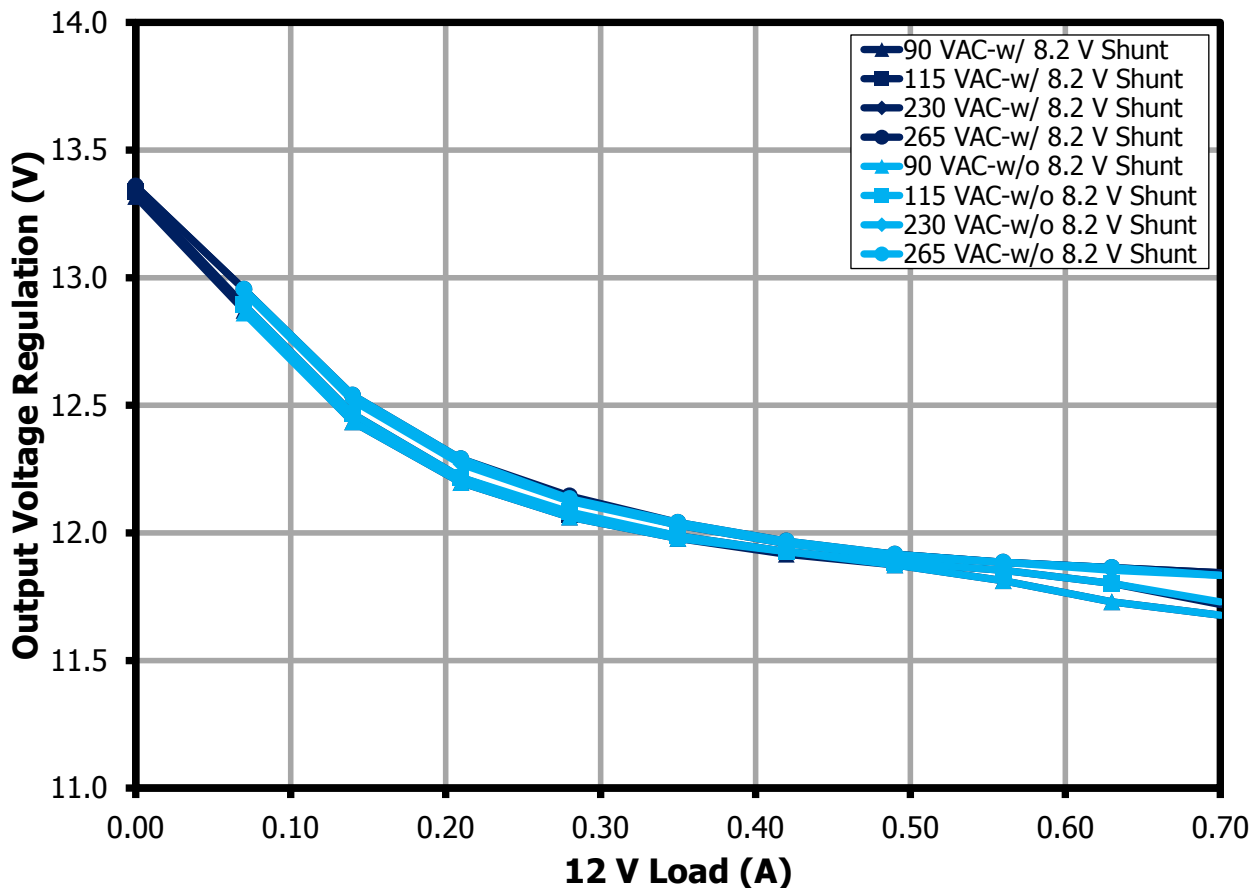

Figure 14 – 12 V Output Voltage vs. Output Load, Room Temperature.

	With Shunt		Without Shunt	
	5 V	12 V	5 V	12 V
Min	4.95 V	11.68 V	*4.97 V	*11.68 V
Max	5.07 V	13.36 V	*5.06 V	*12.95 V

***Note:** Minimum load current without shunt to either load is 10% of the nominal load (30 mA in 5 V and 70 mA to 12 V).

9.6.2.2 12 V Load Change with No Load on 5 V

Zener diode (8.2 V) across 12 V output to 5 V output (minimum load = 0 A) vs. removing the shunt with 10% minimum to either load.

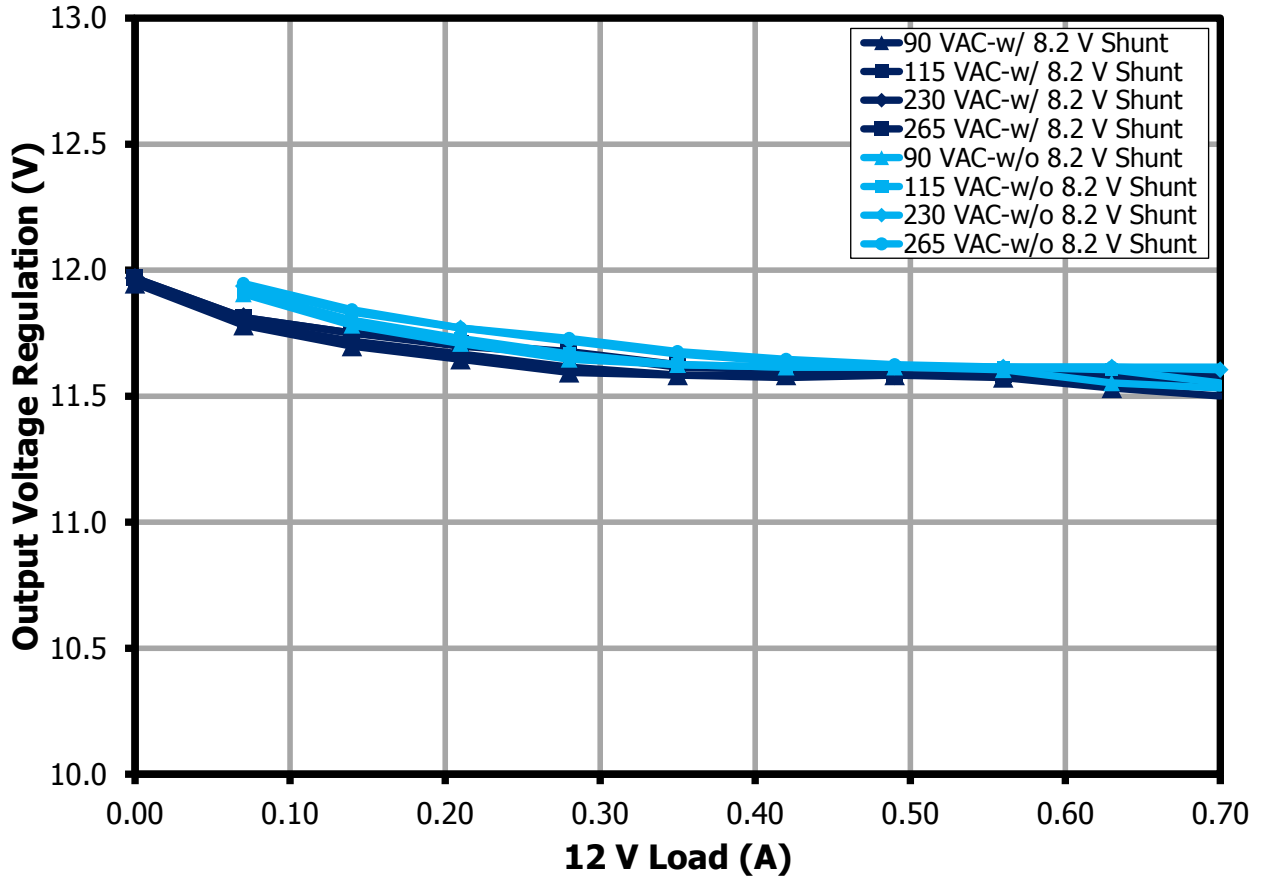

Figure 15 – 12 V Output Voltage vs. Output Load, Room Temperature.

	With Shunt		Without Shunt	
	5V	12V	5 V	12 V
Min	5.07 V	11.50 V	*5.06 V	*11.53 V
Max	5.17 V	11.97 V	*5.15 V	*11.95 V

***Note:** Minimum load current without shunt to either load is 10% of the nominal load (30 mA in 5 V and 70 mA to 12 V).



9.6.2.3 5 V Load Change with Full Load on 12 V

Zener diode (8.2 V) across 12 V output to 5 V output (minimum load = 0 A) vs. removing the shunt with 10% minimum to either load.

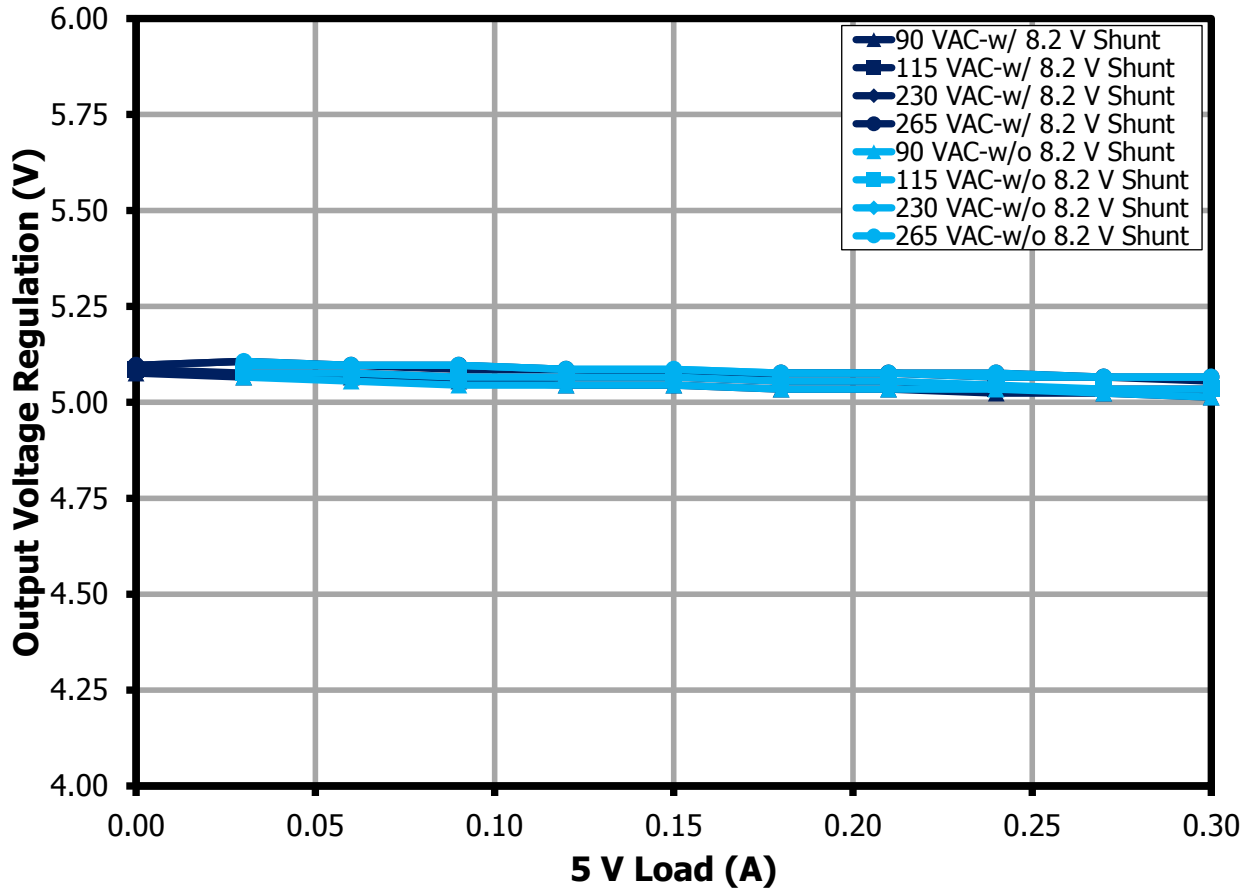

Figure 16 – 5 V Output Voltage vs. Output Load, Room Temperature.

	With Shunt		Without Shunt	
	5 V	12 V	5 V	12 V
Min	5.01 V	11.50 V	*5.01 V	*11.51 V
Max	5.11 V	11.82 V	*5.10 V	*11.81 V

***Note:** Minimum Load current without shunt to either load is 10% of the nominal load (30 mA in 5 V and 70 mA to 12 V).

9.6.2.4 5 V Load Change with No Load on 12 V

Zener diode (8.2 V) across 12 V output to 5 V output (minimum load = 0 A) vs. removing the shunt with 10% minimum to either load.

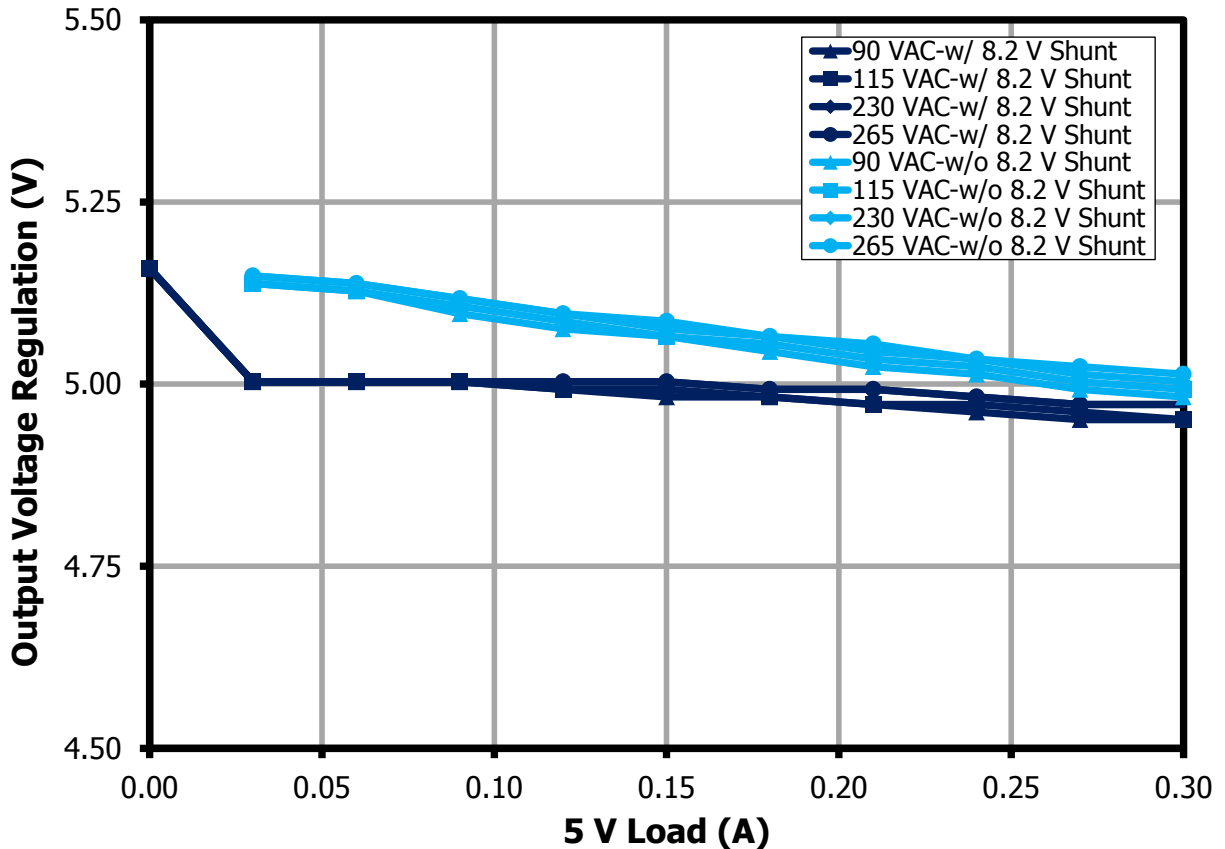

Figure 17 – 5 V Output Voltage vs. Output Load, Room Temperature.

	With Shunt		Without Shunt	
	5 V	12 V	5 V	12 V
Min	4.95 V	11.86 V	*4.98 V	*11.89 V
Max	5.00 V	13.36 V	*5.15 V	*12.95 V

***Note:** Minimum Load current without shunt to either load is 10% of the nominal load (30 mA in 5 V and 70 mA to 12 V).



10 Thermal Performance

10.1 90 VAC

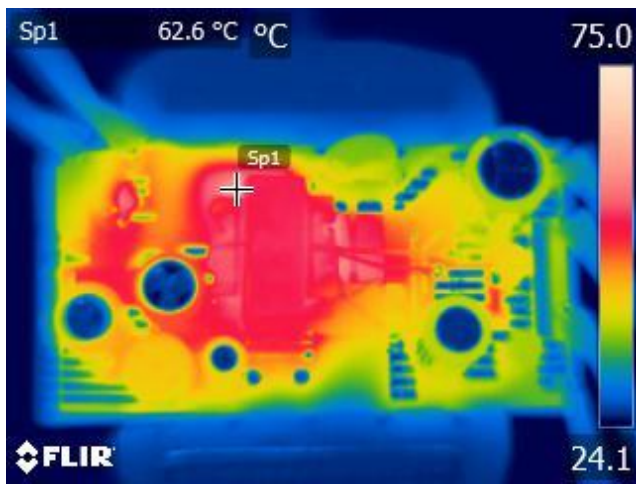

Figure 18 – Transformer Side. 90 VAC, Full Load.

	Reference	°C
Ambient		24.9
Transformer	T1	62.6
Thermistor	RT1	59.4

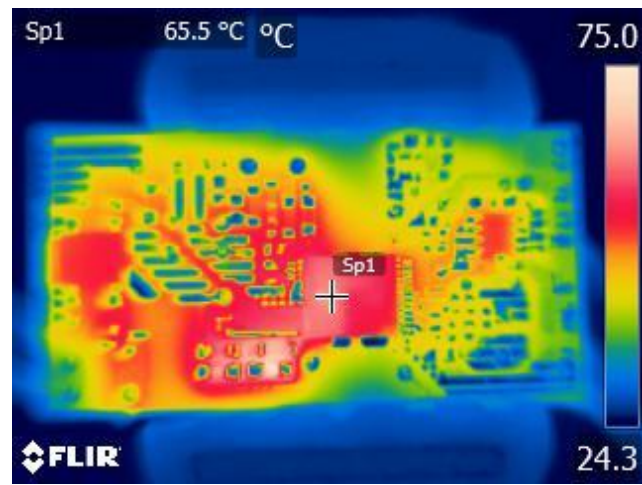

Figure 19 – InnoSwitch3-EP Side. 90 VAC, Full Load.

	Reference	°C
Ambient		25.2
InnoSwitch3-EP	U1	65.5
SR FET Q1	Q1	44.7
SR FET Q2	Q2	53.8
Clamp Resistor	R22	74.6
Snubber Diode	D1	69.3
Bridge Diode	BR1	55.6

10.2 **265 VAC**

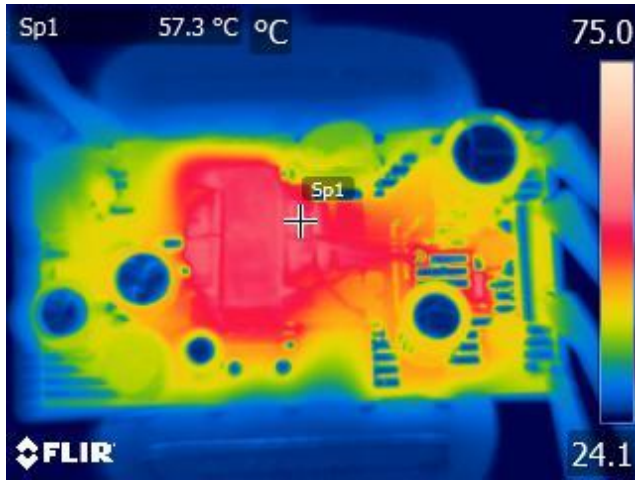

Figure 20 – Transformer Side. 265 VAC, Full Load.

	Reference	°C
Ambient		24.8
Transformer	T1	57.3
Thermistor	RT1	42.5

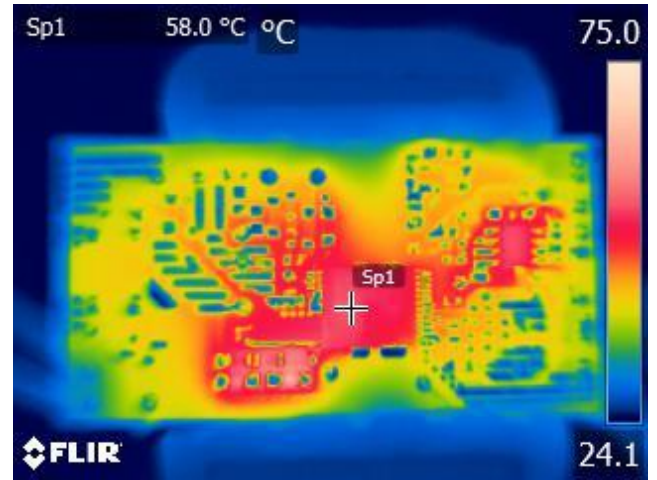

Figure 21 – InnoSwitch3-EP Side. 265 VAC, Full Load.

	Reference	°C
Ambient		25.3
InnoSwitch3-EP	U1	58.0
SR FET Q1	Q1	46.5
SR FET Q2	Q2	56.7
Clamp Resistor	R22	65.8
Snubber Diode	D1	60.4
Bridge Diode	BR1	44.3

11 Over Temperature Protection (OTP)

11.1 90 VAC

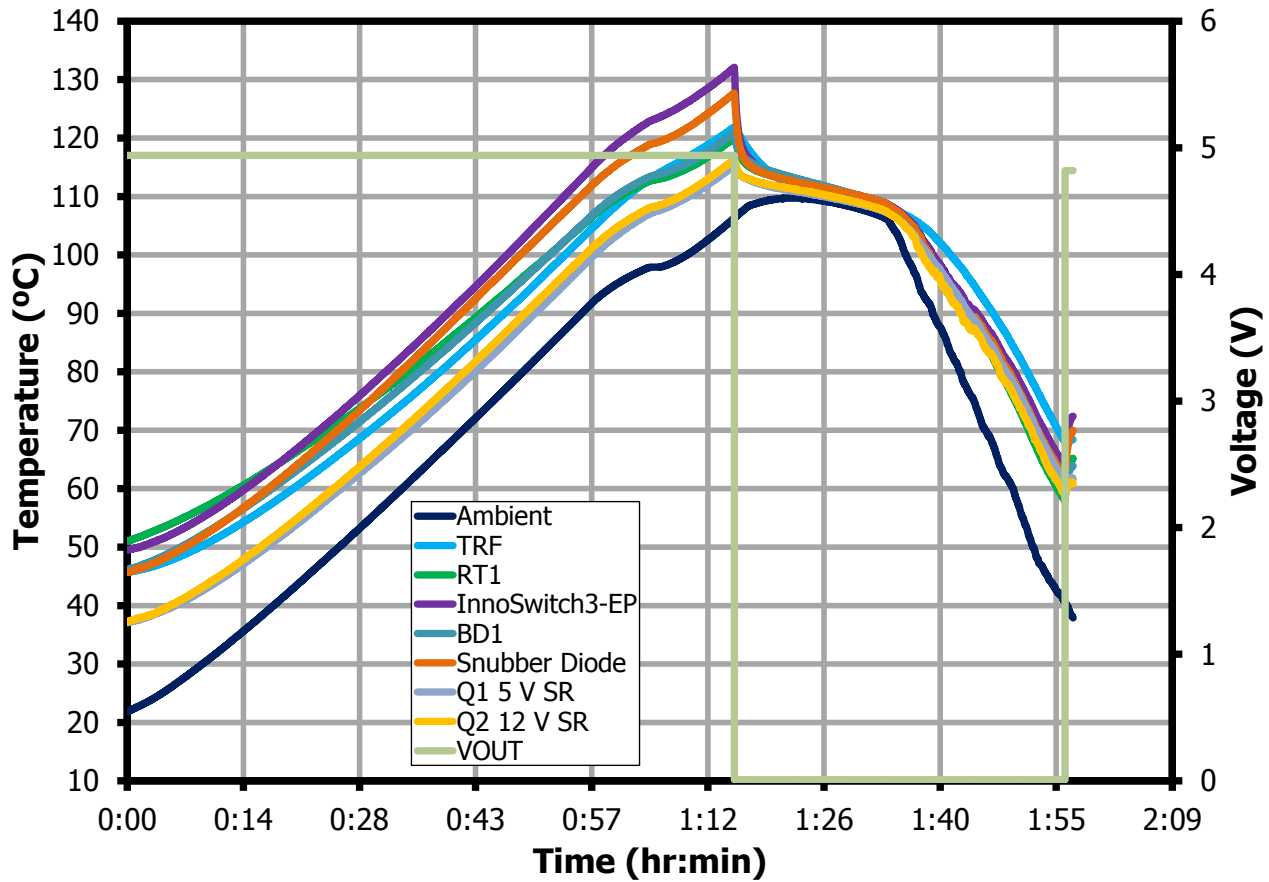

Figure 22 – Temperature vs. Time, 90 VAC.

11.2 265 VAC

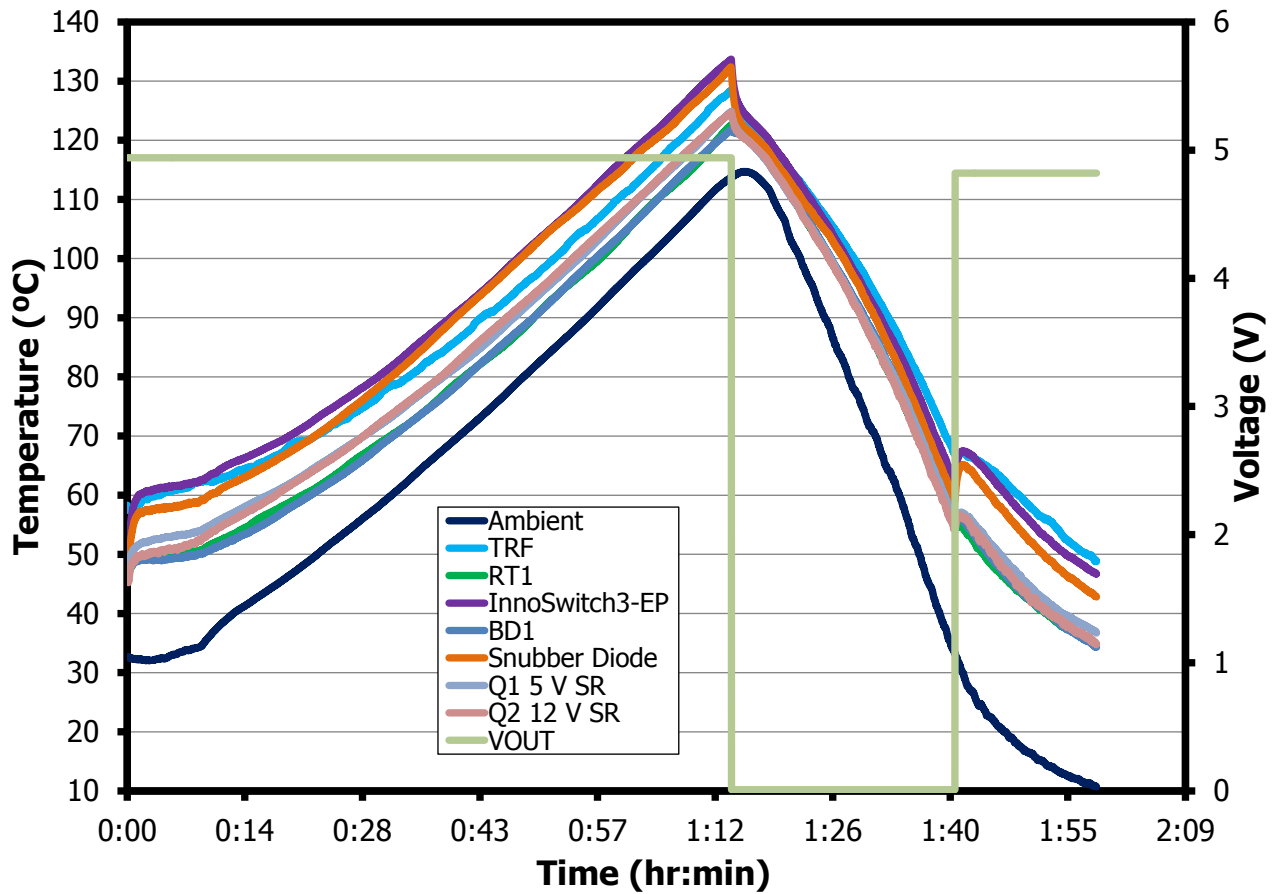

Figure 23 – Temperature vs. Time, 265 VAC.



12 Waveforms

12.1 Load Transient Response

12.1.1 12 V Load Transient – No-Load at 5 V Output

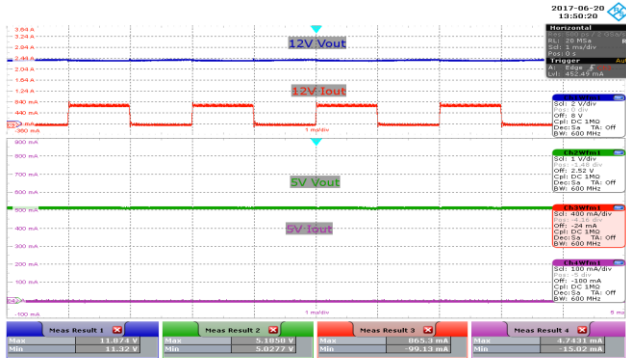

Figure 24 – 0 A – 0.7 A, 12 V Load Step Transient Response, 90 VAC.
 $5 V_{MIN}$: 5.02 V.; $5 V_{MAX}$: 5.18 V.
 $12 V_{MIN}$: 11.32 V. $12 V_{MAX}$: 11.87 V.
 Upper: 12 V_{OUT}, 2 V / div.
 Upper Middle: 12 V I_{OUT}. 400 mA / div.
 Upper Middle: 5 V_{OUT}, 1 V / div.
 Lower: 5 V I_{OUT}, 100 mA / div., 1 ms / div.

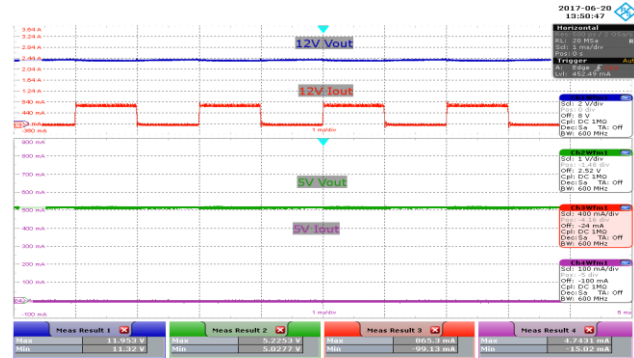

Figure 25 – 0 A – 0.7 A, 12 V Load Step Transient Response. 265 VAC.
 $5 V_{MIN}$: 5.02 V.; $5 V_{MAX}$: 5.22 V.
 $12 V_{MIN}$: 11.32 V.; $12 V_{MAX}$: 11.95 V.
 Upper: 12 V_{OUT}, 2 V / div.
 Upper Middle: 12 V I_{OUT}. 400 mA / div.
 Upper Middle: 5 V_{OUT}, 1 V / div.
 Lower: 5 V I_{OUT}, 100 mA / div., 1 ms / div.

12.1.2 5 V Load Transient – No-Load at 12 V Output

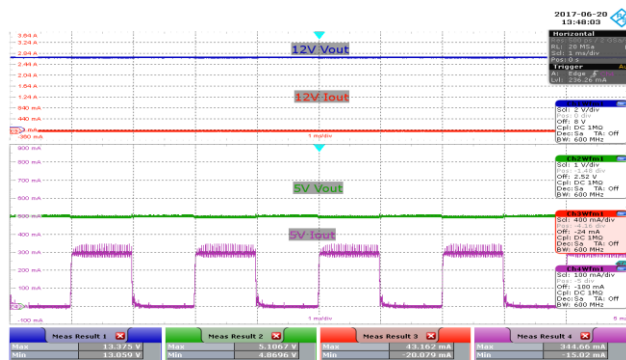

Figure 26 – 0 A – 0.3 A, 5 V Load Step Transient Response, 90 VAC.
 $5 V_{MIN}$: 4.86 V.; $5 V_{MAX}$: 5.10 V.
 $12 V_{MIN}$: 13.05 V. $12 V_{MAX}$: 13.37 V.
 Upper: 12 V_{OUT}, 2 V / div.
 Upper Middle: 12 V I_{OUT}. 400 mA / div.
 Upper Middle: 5 V_{OUT}, 1 V / div.
 Lower: 5 V I_{OUT}, 100 mA / div., 1 ms / div.

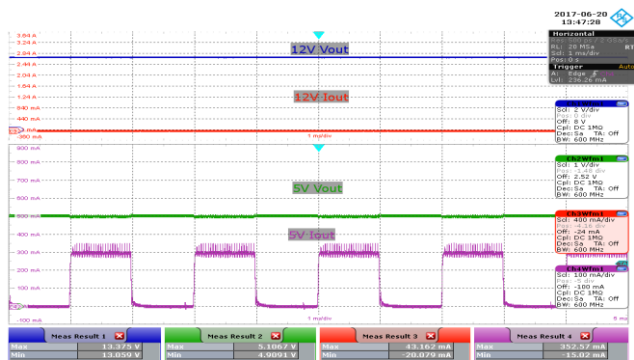

Figure 27 – 0 A – 0.3 A, 5 V Load Step Transient Response. 265 VAC.
 $5 V_{MIN}$: 4.90 V.; $5 V_{MAX}$: 5.10 V.
 $12 V_{MIN}$: 13.05 V. $12 V_{MAX}$: 13.37 V.
 Upper: 12 V_{OUT}, 2 V / div.
 Upper Middle: 12 V I_{OUT}. 400 mA / div.
 Upper Middle: 5 V_{OUT}, 1 V / div.
 Lower: 5 V I_{OUT}, 100 mA / div., 1 ms / div.



12.2 Switching Waveforms

12.2.1 InnoSwitch3-EP Waveforms

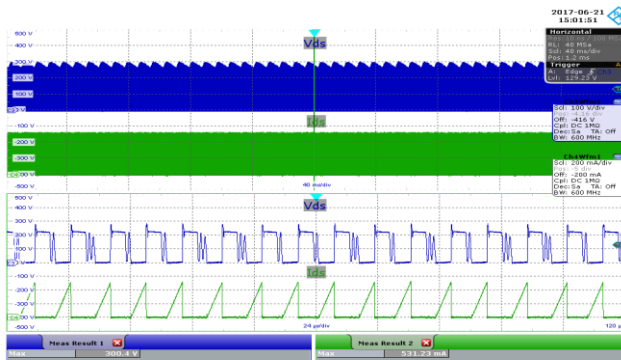

Figure 28 – Drain Voltage and Current Waveforms.
90 VAC Input, Full Load.
Upper: V_{DRAIN} , 100 V, 40 ms, 24 μ s / div.
Lower: I_{DRAIN} , 200 mA / div.

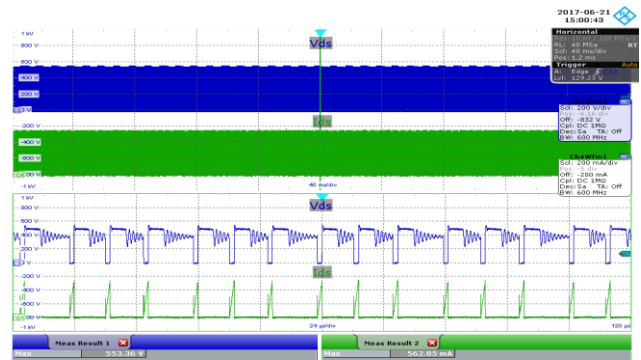

Figure 29 – Drain Voltage and Current Waveforms.
265 VAC Input, Full Load, (553 V_{MAX}).
Upper: V_{DRAIN} , 200 V, 40 ms, 24 μ s / div.
Lower: I_{DRAIN} , 200 mA / div.

12.2.2 InnoSwitch3-EP Drain Voltage and Current Waveforms During Start-up

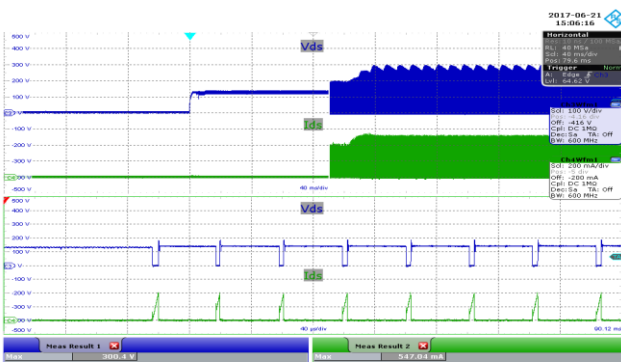

Figure 30 – Drain Voltage and Current Waveforms.
90 VAC Input, Full Load.
Upper: V_{DRAIN} , 100 V, 40 ms, 40 μ s / div.
Lower: I_{DRAIN} , 200 mA / div.

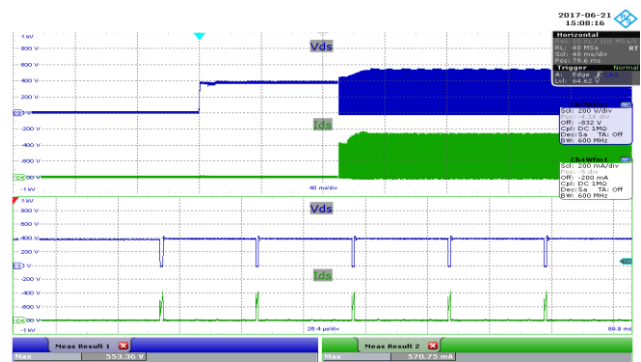

Figure 31 – Drain Voltage and Current Waveforms.
265 VAC Input, Full Load, (553 V_{MAX}).
Upper: V_{DRAIN} , 200 V, 40 ms, 26.4 μ s / div.
Lower: I_{DRAIN} , 200 mA / div.

12.2.3 SR FET Waveforms

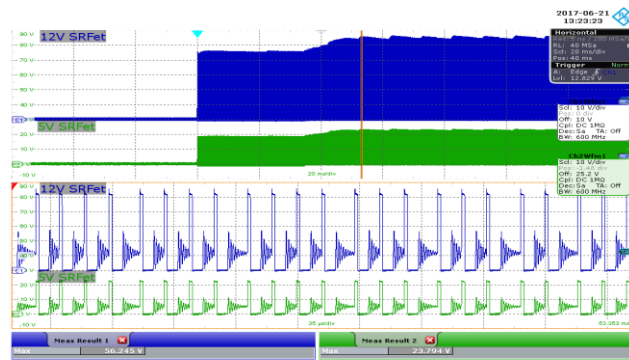
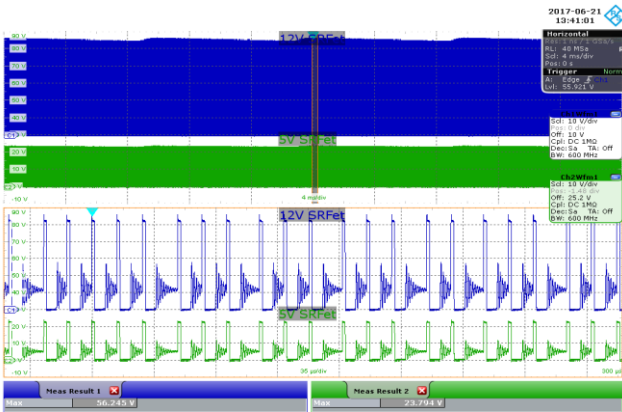

Figure 32 – SR FET Voltage Waveforms.
 265 VAC Input, Full Load.
 (57 V_{MAX} for 12 V, 24 V_{MAX} for 5 V.)
 Upper: 12 V, 10 V / div.
 Lower: 5 V, 10 V /, 4 ms, 35 μs / div.

Figure 33 – SR FET Voltage Waveforms During Start-Up.
 265 VAC Input, Full Load.
 (57 V_{MAX} for 12 V, 24 V_{MAX} for 5 V.)
 Upper: 12 V, 10 V / div.
 Lower: 5 V, 10 V /, 10 ms, 35 μs / div.

12.2.4 Output Voltage and Current Waveforms During Start-Up

12.2.4.1 Full load

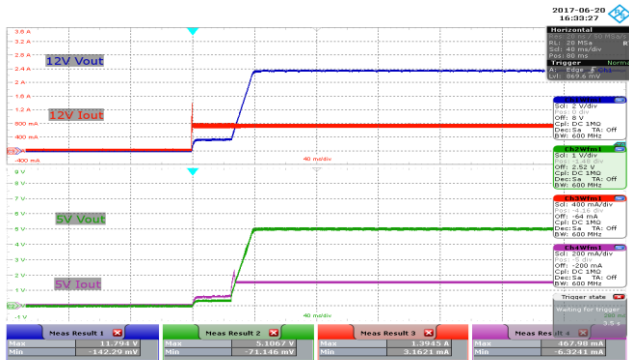

Figure 34 – Output Voltage and Current Waveforms. 90 VAC Input. Upper: 12 V, 2 V / div. Lower: 5 V, 1 V, 10 ms / div.

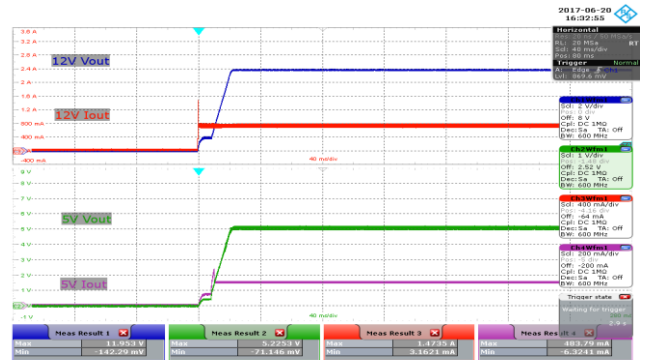

Figure 35 – Output Voltage and Current Waveforms. 265 VAC Input. Upper: 12 V, 2 V / div. Lower: 5 V, 1 V, 10 ms / div.

12.2.4.2 No-Load

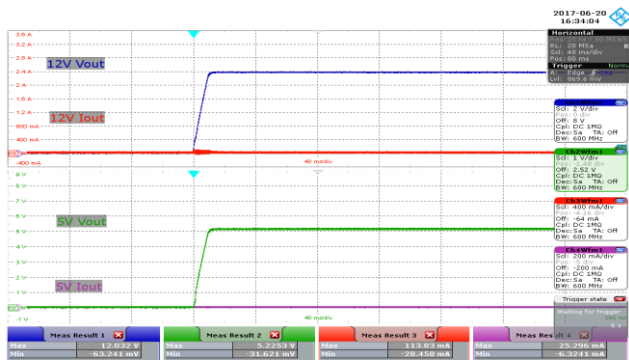

Figure 36 – Output Voltage and Current Waveforms. 90 VAC Input. Upper: 12 V, 2 V / div. Lower: 5 V, 1 V, 10 ms / div.

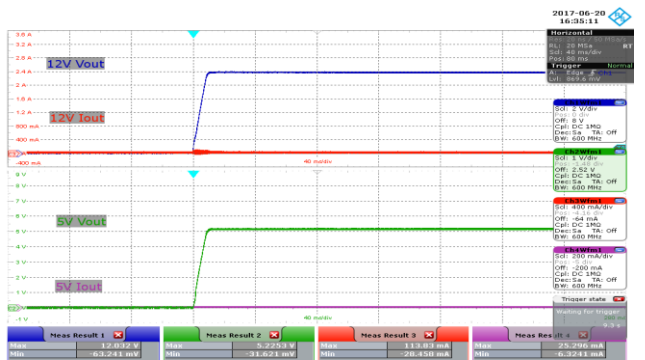

Figure 37 – Output Voltage and Current Waveforms. 265 VAC Input. Upper: 12 V, 2 V / div. Lower: 5 V, 1 V, 10 ms / div.



12.2.5 Output Voltage and Current Waveform with Shorted Output (12 V)

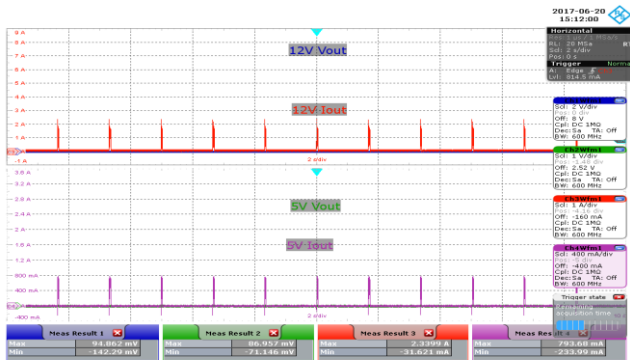

Figure 38 – Output Voltage and Current Waveforms. 90 VAC Input.
 Upper: 12 V_{OUT}, 2 V / div.
 Upper: 12 V I_{OUT}, 1 A / div.
 Lower: 5 V_{OUT}, 1 V / div.
 Lower: 5 V I_{OUT}, 400 mA / div., 2 s / div.

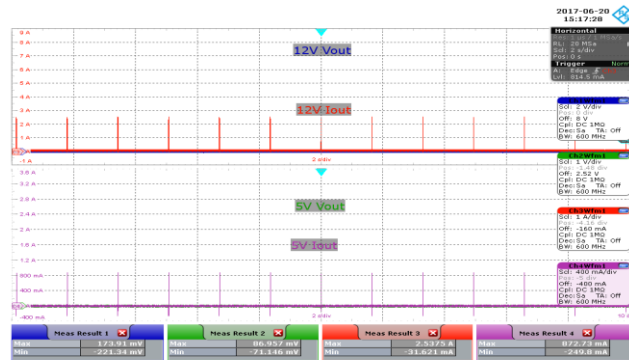

Figure 39 – Output Voltage and Current Waveforms. 265 VAC Input.
 Upper: 12 V_{OUT}, 2 V / div.
 Upper: 12 V I_{OUT}, 1 A / div.
 Lower: 5 V_{OUT}, 1 V / div.
 Lower: 5 V I_{OUT}, 400 mA / div., 2 s / div.

12.2.6 Overvoltage Protection
(OVP while power supply was in operation.)

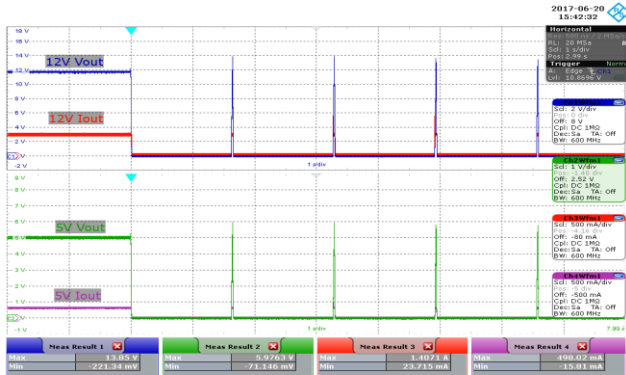

Figure 40 – Output Voltage Waveform.
90 VAC Input.
Upper: 12 V_{OUT}, 2 V / div.
Upper: 12 V I_{OUT}, 500 mA / div.
Lower: 5 V_{OUT}, 1 V / div.
Lower: 5 V I_{OUT}, 500 mA / div., 1 s / div.

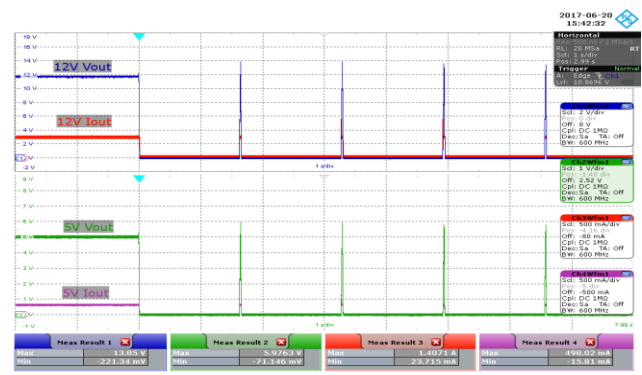

Figure 41 – Output Voltage Waveform.
265 VAC Input.
Upper: 12 V_{OUT}, 2 V / div.
Upper: 12 V I_{OUT}, 1 A / div.
Lower: 5 V_{OUT}, 1 V / div.
Lower: 5 V I_{OUT}, 500 mA / div., 1 s / div.



12.3 **Output Ripple Measurements**

12.3.1 Ripple Measurement Technique

For DC output ripple measurements, a modified oscilloscope test probe must be utilized in order to reduce spurious signals due to pick-up. Details of the probe modification are provided in the Figures below.

The 4987BA probe adapter is affixed with two capacitors tied in parallel across the probe tip. The capacitors include one (1) 0.1 μF /50 V ceramic type and one (1) 47 μF / 50 V aluminum electrolytic. The aluminum electrolytic type capacitor is polarized, so proper polarity across DC outputs must be maintained (see below).

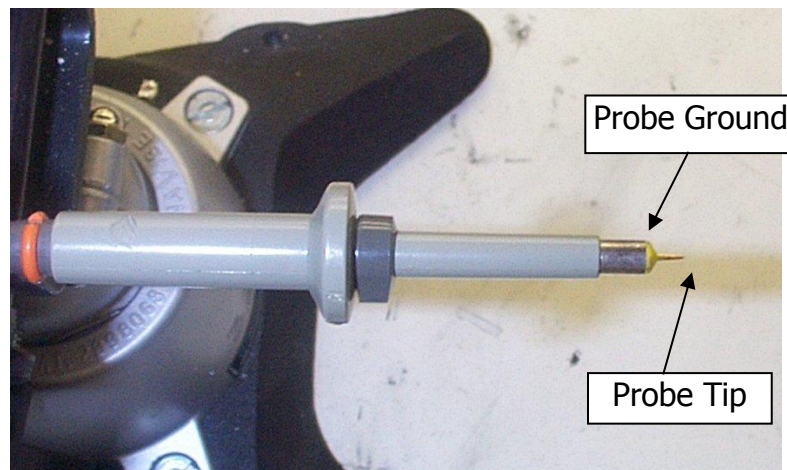

Figure 42 – Oscilloscope Probe Prepared for Ripple Measurement. (End Cap and Ground Lead Removed)



Figure 43 – Oscilloscope Probe with Probe Master (www.probemaster.com) 4987A BNC Adapter. (Modified with wires for ripple measurement, and two parallel decoupling capacitors added)

12.3.2 Ripple Voltage Waveforms

12.3.2.1 0% Load

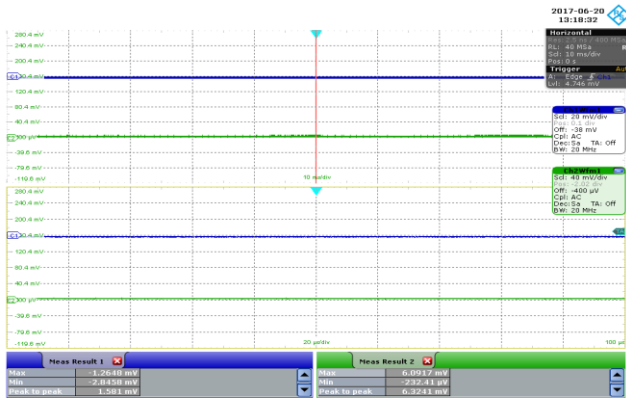

Figure 44 – Output Voltage ripple Waveforms.
 90 VAC Input.
 5 V_{PK} : 2 mV, 12 V_{PK} : 7 mV.
 Upper: 5 V, 20 mV / div.
 Lower: 12 V, 40 mV / , 10 ms, 20 μ s / div.

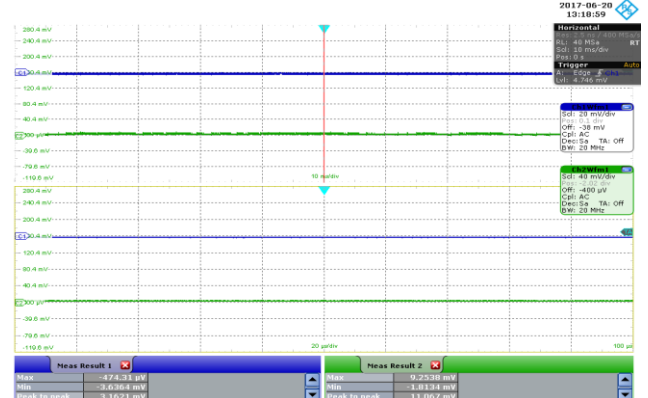

Figure 45 – Output Ripple Voltage Waveforms.
 265 VAC Input.
 5 V_{PK} : 4 mV, 12 V_{PK} : 12 mV.
 Upper: 5 V, 20 mV / div.
 Lower: 12 V, 40 mV / , 10 ms, 20 μ s / div.

12.3.2.2 25% Load

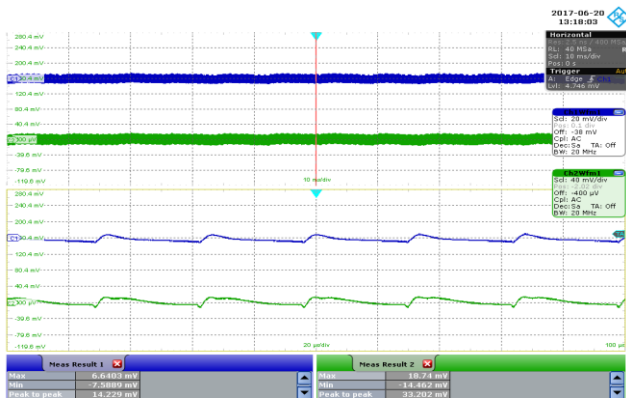

Figure 46 – Output Voltage ripple Waveforms.
 90 VAC Input.
 5 V_{PK} : 15 mV, 12 V_{PK} : 34 mV.
 Upper: 5 V, 20 mV / div.
 Lower: 12 V, 40 mV / , 10 ms, 20 μ s / div.

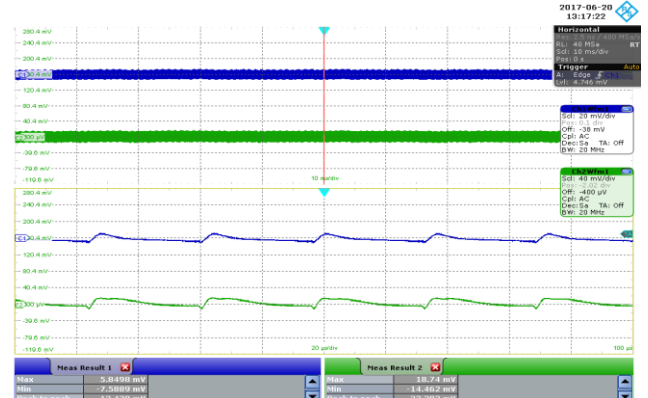

Figure 47 – Output Ripple Voltage Waveforms.
 265 VAC Input.
 5 V_{PK} : 14 mV, 12 V_{PK} : 34 mV.
 Upper: 5 V, 20 mV / div.
 Lower: 12 V, 40 mV / , 10 ms, 20 μ s / div.



12.3.2.3 50% Load

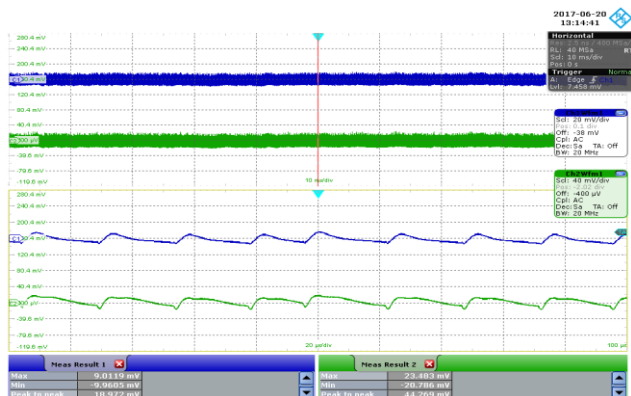

Figure 48 – Output Voltage ripple Waveforms.
 90 VAC Input.
 5 V_{PK}: 19 mV, 12 V_{PK}: 45 mV.
 Upper: 5 V, 20 mV / div.
 Lower: 12 V, 40 mV /, 10 ms, 20 μs / div.

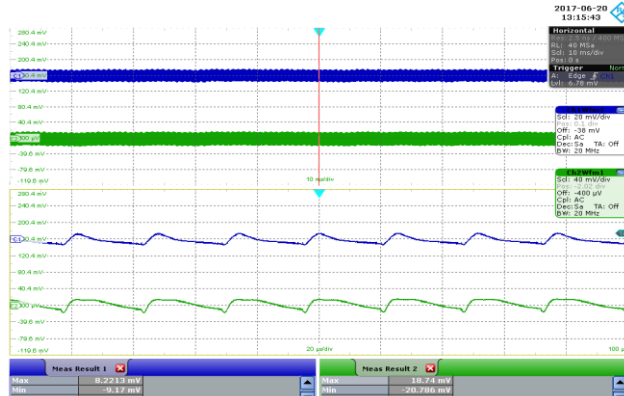

Figure 49 – Output Ripple Voltage Waveforms.
 265 VAC Input.
 5 V_{PK}: 18 mV, 12 V_{PK}: 40 mV.
 Upper: 5 V, 20 mV / div.
 Lower: 12 V, 40 mV /, 10 ms, 20 μs / div.

12.3.2.4 75% Load

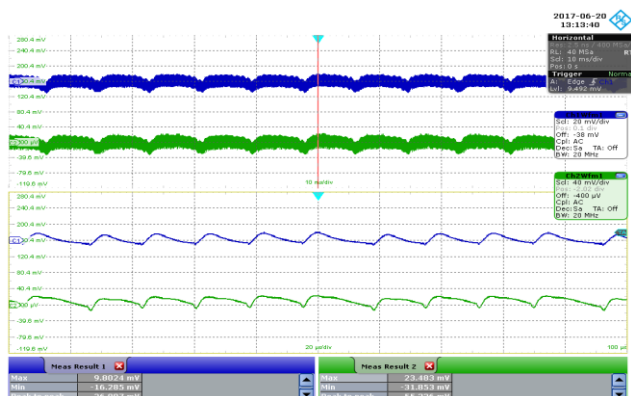

Figure 50 – Output Voltage ripple Waveforms.
 90 VAC Input.
 5 V_{PK}: 27 mV, 12 V_{PK}: 56 mV.
 Upper: 5 V, 20 mV / div.
 Lower: 12 V, 40 mV /, 10 ms, 20 μs / div.

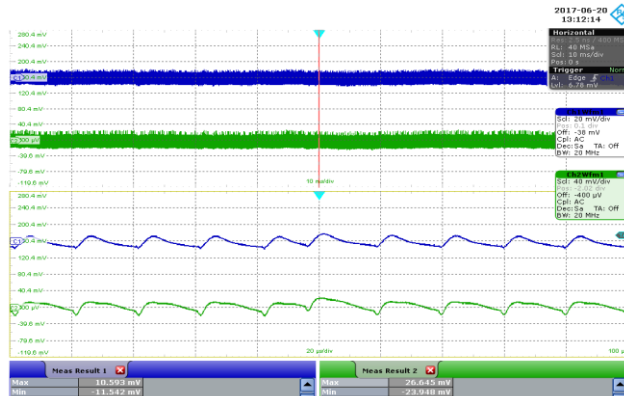

Figure 51 – Output Ripple Voltage Waveforms.
 265 VAC Input.
 5 V_{PK}: 23 mV, 12 V_{PK}: 51 mV.
 Upper: 5 V, 20 mV / div.
 Lower: 12 V, 40 mV /, 10 ms, 20 μs / div.

12.3.2.5 100% Load

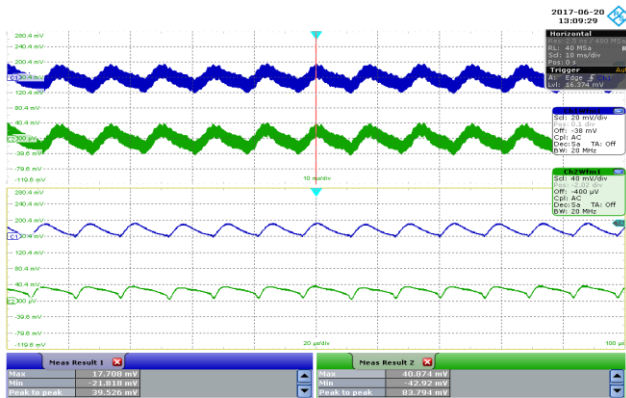

Figure 52 – Output Voltage ripple Waveforms.
 90 VAC Input.
 5 V_{PK}: 40 mV, 12 V_{PK}: 84 mV.
 Upper: 5 V, 20 mV / div.
 Lower: 12 V, 40 mV /, 10 ms, 20 μs / div.

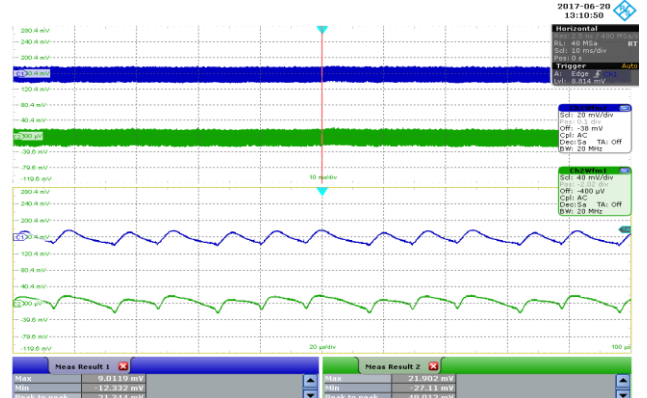

Figure 53 – Output Ripple Voltage Waveforms.
 265 VAC Input.
 5 V_{PK}: 22 mV, 12 V_{PK}: 50 mV.
 Upper: 5 V, 20 mV / div.
 Lower: 12 V, 40 mV /, 10 ms, 20 μs / div.

12.4 **Brown-in and Brown out**

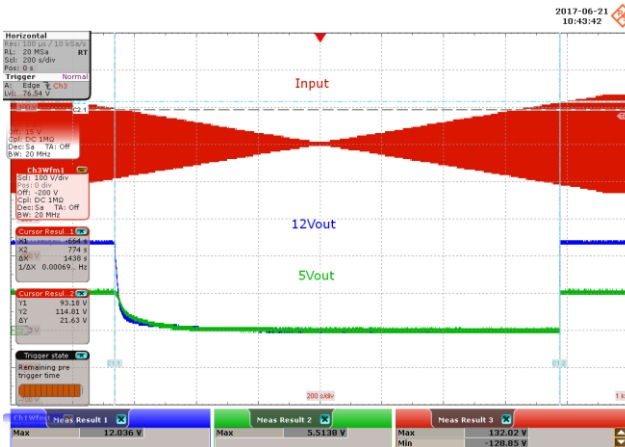

Figure 54 – Line Undervoltage.
 AC Input, No-Load.
 V_{UV+}: 114 V, V_{UV-}: 93 V
 Upper: Input, 100 V / div.
 Middle: 12 V, 5 V / div.
 Lower: 5 V, 5 V /, 200 s / div.

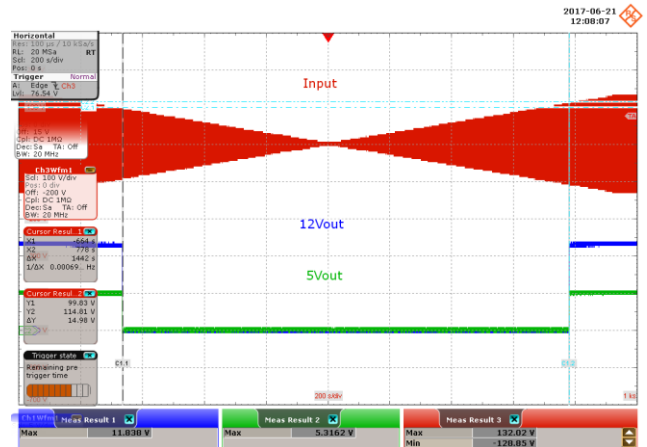

Figure 55 – Line Overvoltage.
 AC Input, Full-Load.
 V_{UV+}: 114 V, V_{UV-}: 99 V
 Upper: Input, 100 V / div.
 Middle: 12 V, 5 V / div.
 Lower: 5 V, 5 V /, 200 s / div.



13 EMI

13.1 Conductive EMI

13.1.1 Floating Output (QP / AV)

13.1.1.1 110 VAC Input

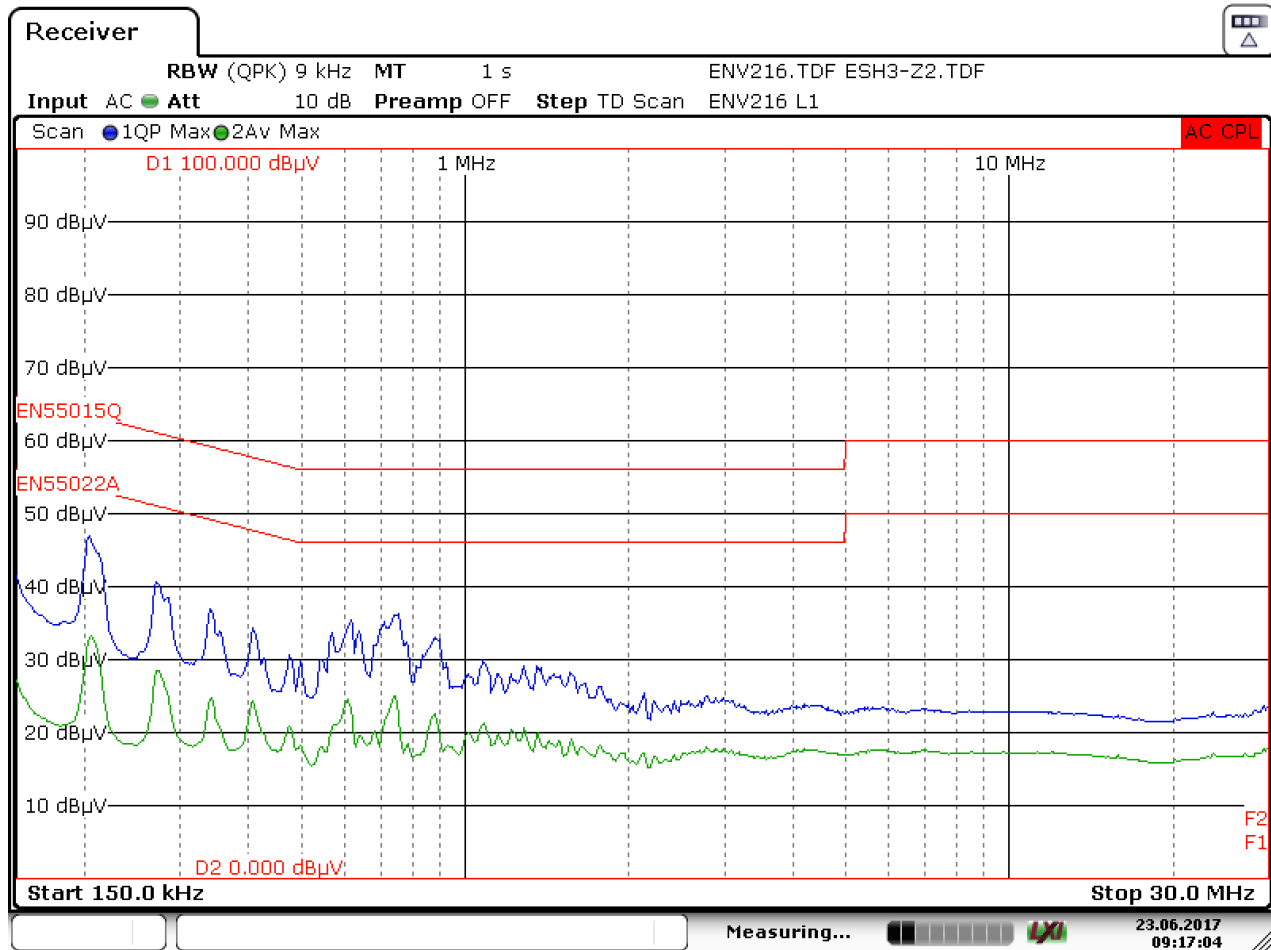

Date: 23.JUN.2017 09:17:04

Figure 56 – Floating Ground - 110 VAC Line.



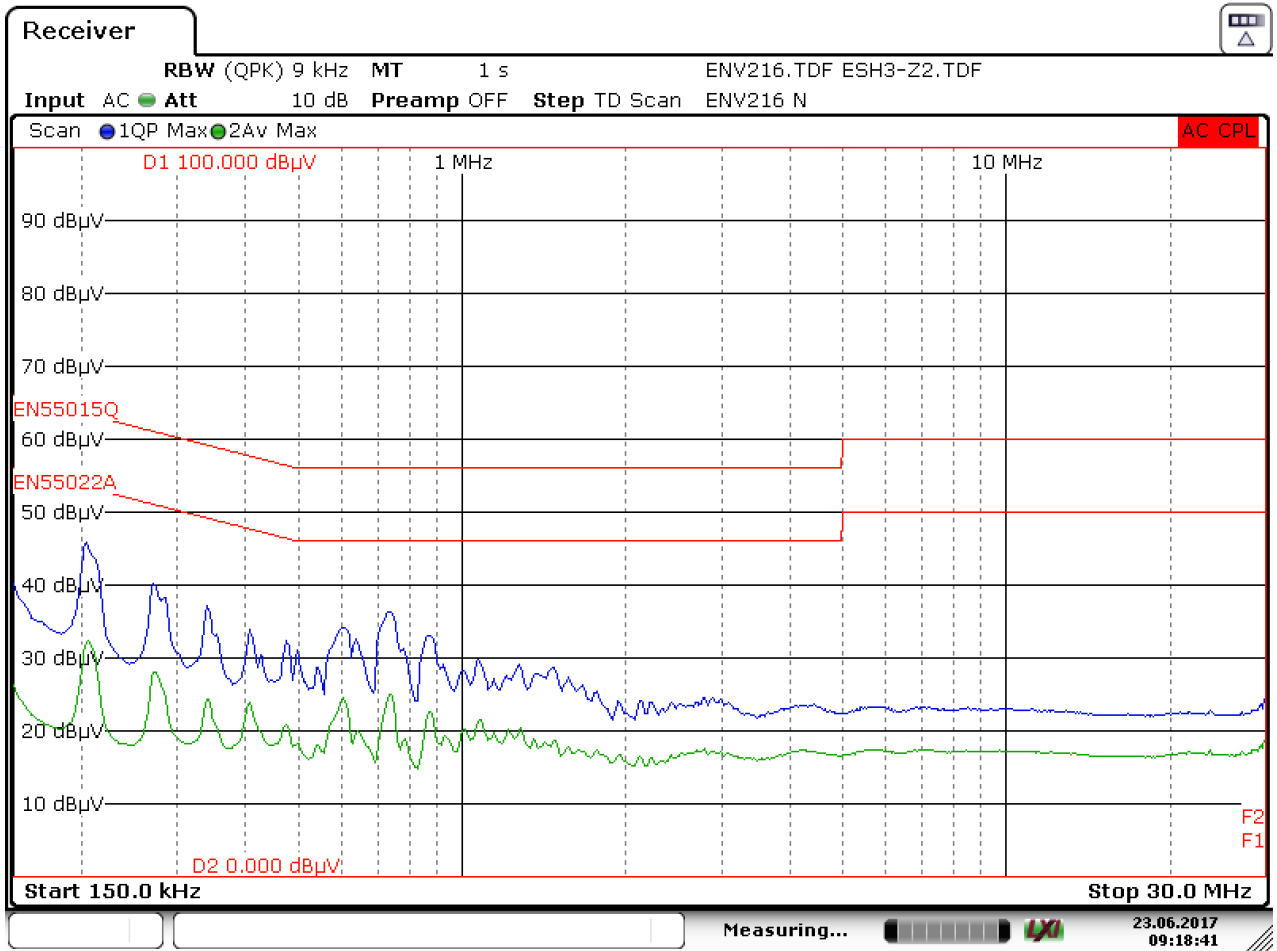

Date: 23.JUN.2017 09:18:41

Figure 57 – Floating Ground - 110 VAC Neutral.



13.1.1.2 230 VAC Input

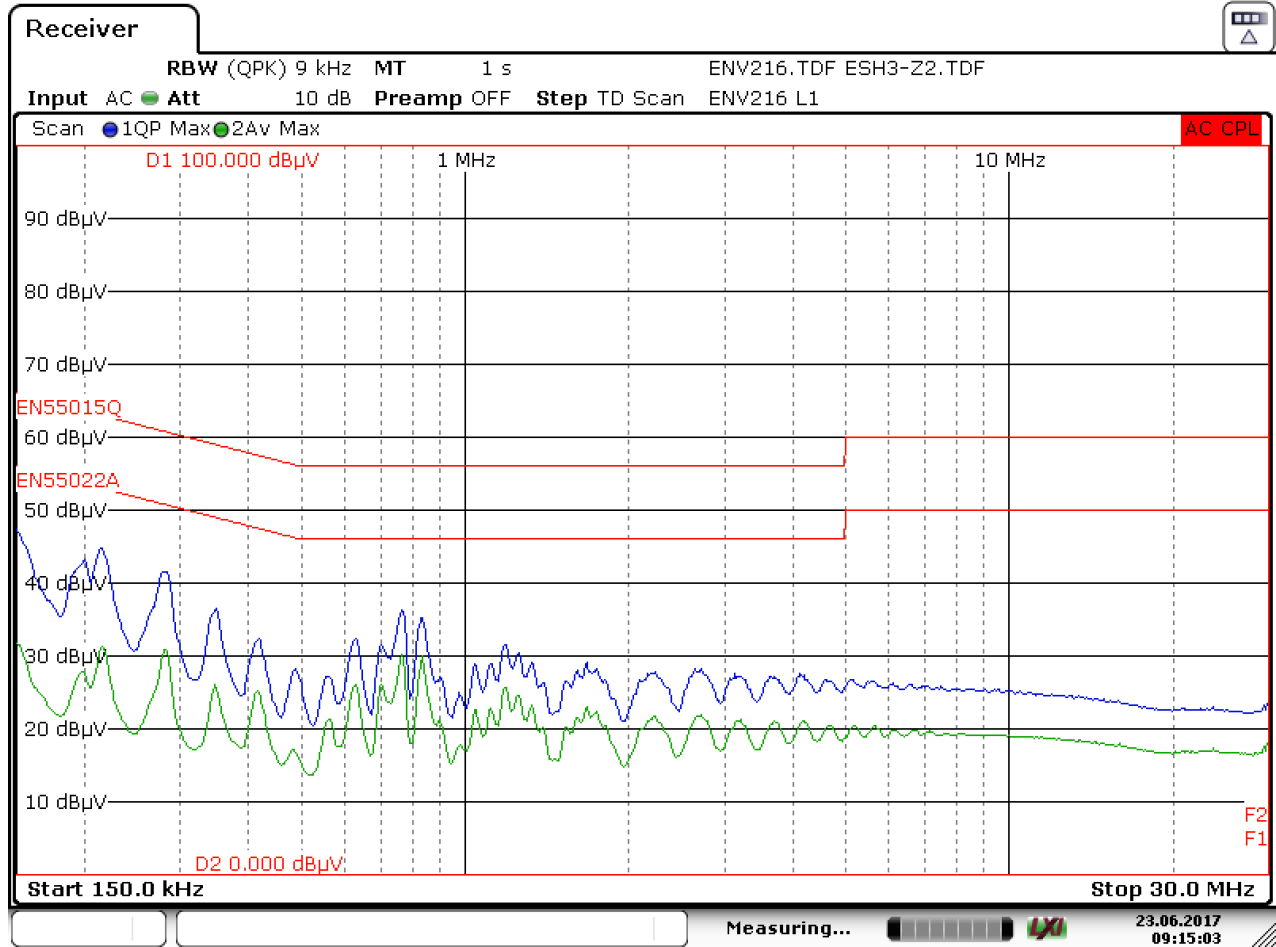

Date: 23.JUN.2017 09:15:03

Figure 58 – Floating Ground - 230 VAC Line.



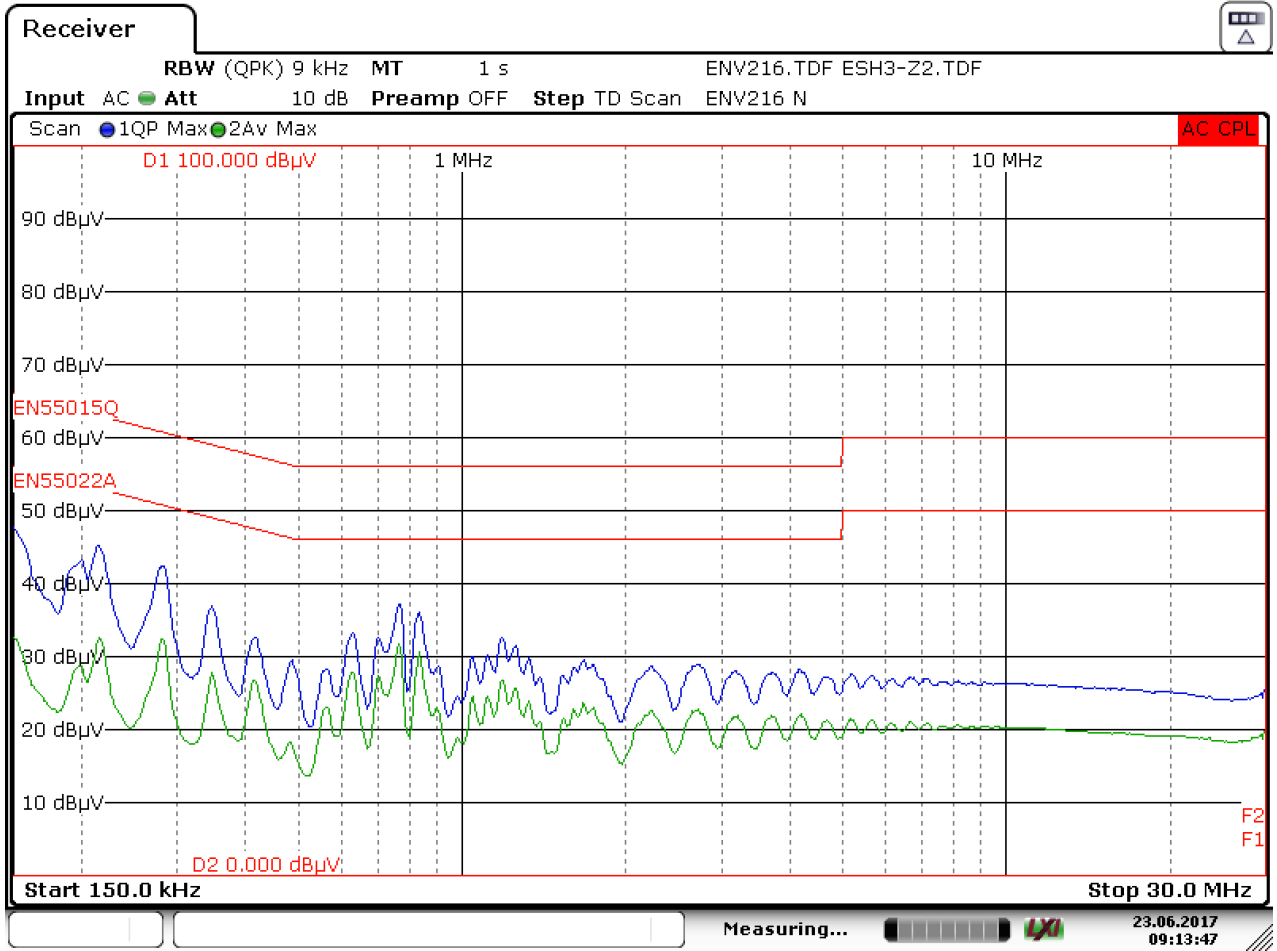

Date: 23.JUN.2017 09:13:47

Figure 59 – Floating Ground - 230 VAC Neutral.



14 Lighting Surge Test

14.1 Differential Mode Test

Passed ± 1 kV, 500 A surge test.

Surge Voltage (kV)	Phase Angle (°)	Generator Impedance (Ω)	Number of Strikes	Test Result
1	0	2	10	PASS
-1	0	2	10	PASS
1	90	2	10	PASS
-1	90	2	10	PASS
1	180	2	10	PASS
-1	180	2	10	PASS
1	270	2	10	PASS
-1	270	2	10	PASS

14.2 Common Mode Test

Passed ± 2 kV, ring wave test.

Ring Wave Voltage (kV)	Phase Angle (°)	Generator Impedance (Ω)	Number of Strikes	Test Result
2	0	12	10	PASS
-2	0	12	10	PASS
2	90	12	10	PASS
-2	90	12	10	PASS
2	180	12	10	PASS
-2	180	12	10	PASS
2	270	12	10	PASS
-2	270	12	10	PASS

15 ESD Test

Passed ± 8 kV contact discharge.

Contact Voltage (kV)	Applied to	Number of Strikes	Test Result
8	5 V Positive	10	PASS
-8	5 V Negative	10	PASS
8	12 V Positive	10	PASS
-8	12 V Negative	10	PASS

Passed ± 16 kV air discharge.

Differential Voltage (kV)	Applied to	Number of Strikes	Test Result
16	5 V Positive	10	PASS
-16	5 V Negative	10	PASS
16	12 V Positive	10	PASS
-16	12 V Negative	10	PASS

16 Revision History

Date	Author	Revision	Description & Changes	Reviewed
07-Sep-17	JRV / DK	1.0	Initial Release.	Apps & Mktg
21-Sep-17	KM	1.1	Added Test Points to the BOM.	
02-May-18	KM	1.2	Added Transformer Supplier for T1	
29-Jan-19	KM	1.3	Corrected Schematic.	



For the latest updates, visit our website: www.power.com

Reference Designs are technical proposals concerning how to use Power Integrations' gate drivers in particular applications and/or with certain power modules. These proposals are "as is" and are not subject to any qualification process. The suitability, implementation and qualification are the sole responsibility of the end user. The statements, technical information and recommendations contained herein are believed to be accurate as of the date hereof. All parameters, numbers, values and other technical data included in the technical information were calculated and determined to our best knowledge in accordance with the relevant technical norms (if any). They may base on assumptions or operational conditions that do not necessarily apply in general. We exclude any representation or warranty, express or implied, in relation to the accuracy or completeness of the statements, technical information and recommendations contained herein. No responsibility is accepted for the accuracy or sufficiency of any of the statements, technical information, recommendations or opinions communicated and any liability for any direct, indirect or consequential loss or damage suffered by any person arising therefrom is expressly disclaimed.

Power Integrations reserves the right to make changes to its products at any time to improve reliability or manufacturability. Power Integrations does not assume any liability arising from the use of any device or circuit described herein. POWER INTEGRATIONS MAKES NO WARRANTY HEREIN AND SPECIFICALLY DISCLAIMS ALL WARRANTIES INCLUDING, WITHOUT LIMITATION, THE IMPLIED WARRANTIES OF MERCHANTABILITY, FITNESS FOR A PARTICULAR PURPOSE, AND NON-INFRINGEMENT OF THIRD PARTY RIGHTS.

Patent Information

The products and applications illustrated herein (including transformer construction and circuits' external to the products) may be covered by one or more U.S. and foreign patents, or potentially by pending U.S. and foreign patent applications assigned to Power Integrations. A complete list of Power Integrations' patents may be found at www.power.com. Power Integrations grants its customers a license under certain patent rights as set forth at <http://www.power.com/ip.htm>.

The PI Logo, TOPSwitch, TinySwitch, LinkSwitch, LYTSwitch, InnoSwitch, DPA-Switch, PeakSwitch, CAPZero, SENZero, LinkZero, HiperPFS, HiperTFS, HiperLCS, Qspeed, EcoSmart, Clampless, E-Shield, Filterfuse, FluxLink, StackFET, PI Expert and PI FACTS are trademarks of Power Integrations, Inc. Other trademarks are property of their respective companies. ©Copyright 2015 Power Integrations, Inc.

Power Integrations Worldwide Sales Support Locations

WORLD HEADQUARTERS

5245 Hellyer Avenue
San Jose, CA 95138, USA.
Main: +1-408-414-9200
Customer Service:
Phone: +1-408-414-9665
Fax: +1-408-414-9765
e-mail: usasales@power.com

GERMANY

(IGBT Driver Sales)
HellwegForum 1
59469 Ense, Germany
Tel: +49-2938-64-39990
Email: igbt-driver.sales@power.com

KOREA

RM 602, 6FL
Korea City Air Terminal B/D,
159-6
Samsung-Dong, Kangnam-Gu,
Seoul, 135-728 Korea
Phone: +82-2-2016-6610
Fax: +82-2-2016-6630
e-mail: koreasales@power.com

CHINA (SHANGHAI)

Rm 2410, Charity Plaza, No.
88,
North Caoxi Road,
Shanghai, PRC 200030
Phone: +86-21-6354-6323
Fax: +86-21-6354-6325
e-mail:
chinasales@power.com

INDIA

#1, 14th Main Road
Vasanthanagar
Bangalore-560052
India
Phone: +91-80-4113-8020
Fax: +91-80-4113-8023
e-mail:
indiasales@power.com

SINGAPORE

51 Newton Road,
#19-01/05 Goldhill Plaza
Singapore, 308900
Phone: +65-6358-2160
Fax: +65-6358-2015
e-mail:
singaporesales@power.com

CHINA (SHENZHEN)

17/F, Hivac Building, No. 2, Keji
Nan 8th Road, Nanshan District,
Shenzhen, China, 518057
Phone: +86-755-8672-8689
Fax: +86-755-8672-8690
e-mail: chinasales@power.com

ITALY

Via Milanese 20, 3rd. Fl.
20099 Sesto San Giovanni (MI)
Italy
Phone: +39-024-550-8701
Fax: +39-028-928-6009
e-mail: eurosales@power.com

TAIWAN

5F, No. 318, Nei Hu Rd.,
Sec. 1
Nei Hu District
Taipei 11493, Taiwan R.O.C.
Phone: +886-2-2659-4570
Fax: +886-2-2659-4550
e-mail: taiwansales@power.com

GERMANY

(AC-DC/LED Sales)
Lindwurmstrasse 114
80337, Munich
Germany
Phone: +49-895-527-39110
Fax: +49-895-527-39200
e-mail: eurosales@power.com

JAPAN

Kosei Dai-3 Building
2-12-11, Shin-Yokohama,
Kohoku-ku, Yokohama-shi,
Kanagawa 222-0033
Japan
Phone: +81-45-471-1021
Fax: +81-45-471-3717
e-mail: japansales@power.com

UK

Cambridge Semiconductor,
a Power Integrations company
Westbrook Centre, Block 5, 2nd
Floor
Milton Road
Cambridge CB4 1YG
Phone: +44 (0) 1223-446483
e-mail: eurosales@power.com

